



Rapidox 1100LR Oxygen Analyser

Instruction Manual

Revision 1.6

Cambridge Sensotec Limited
Unit 29 Stephenson Road
St Ives
CAMBS
PE27 3WJ

Tel. +44 (0)1480 462142
Fax +44 (0)1480 466032
Mobile (07866) 624236
Sales@Cambridge-Sensotec.co.uk

Declaration of Conformity

Manufacturer: Cambridge Sensotec Limited
Unit 29 Stephenson Road
St Ives
CAMBS
PE27 3WJ

Product Names: Rapidox portable oxygen gas analyser

Model Numbers: RX 1100LR

Conform to the following specifications:

EMC: EN 61326:1998 Electrical equipment for measurement,
control and laboratory use

Declaration: I declare that the above products conform to the applicable requirements of the LVD Directive 73/23/EEC and the EMC Directive 89/336/EEC and is CE marked accordingly.

Signature: 

Name: Dr. Mark Swetnam

Title: Managing Director

Company: Cambridge Sensotec Limited

Date: 1st August 2010

WEEE Regulations 2006



Cambridge Sensotec takes its responsibilities under the WEEE Regulations extremely seriously and has taken steps to be compliant in line with our corporate and social responsibilities. In the UK, Cambridge Sensotec has joined a registered compliance scheme "WeeeCare" (WeeeCare registration number WEE/MP3538PZ/SCH).

UK users only: If you have purchased any electronic or electrical product from Cambridge Sensotec since 2007 and would like to dispose of it correctly under the WEEE scheme, please contact us and we will be happy to either arrange the collection of the waste or have it returned to our offices for recycling. All our in-house manufactured products are scheme compliant and carry the WEEE label indicating that it is NOT allowed to be disposed of in a landfill site.

Contents

1.	Introduction	1
2.	Features	1
3.	Specification.....	2
3.1	Rapidox Dimensions & Power Requirements	2
3.2	Accuracy and Resolution.....	2
3.3	Display	2
3.4	Calibration	2
3.5	Operating Temperature & Pressure	2
3.6	Outputs	3
4.	Technical Specification	3
5.	Precautions.....	3
6.	Warning	4
7.	Rapidox Operating Instructions	4
7.1	The Rapidox Analyser - Menu System.....	5
7.2	Getting Started	5
7.3	Pump Control.....	6
7.4	Menu Access / Passwords.....	6
7.5	Rapidox Calibration.....	6
7.6	Alarms	8
7.7	Analogue Outputs	9
7.8	Setting the Display Units.....	12
7.9	Setting the Display Options.....	12
7.10	Internal Pressure Sensor.....	12
7.11	Pressure Mode.....	13
7.12	Setting the Baud Rate	13
7.13	RS232 / RS485 Port.....	13
7.13.1	RS232 Protocol	13
7.13.2	RS485 protocol	15
7.14	Setting the Date & Time.....	16
7.15	Replacing the Oxygen Sensor.....	16
7.16	Printing.....	17
7.17	Load Defaults	17
8.	Rapidox Software Instructions	18
8.1	Software Installation.....	18
8.2	Getting Started	18
8.3	On-Screen Help.....	19
8.4	Configuration Page.....	19
8.5	Reconfiguring the Analyser	20
8.5.1	Config 1 Screen.....	21
8.5.2	Config 2 Screen.....	22
8.5.3	Alarm Config Screen	23
8.6	On-Screen LCD	24
Remote Calibrating.....		25
8.7.....		25
8.8	Calibration Error Messages.....	26

Cambridge Sensotec Rapidox 1100LR Oxygen Analyser Instruction Manual

8.9	Replacing the sensor	27
8.10	Software Utilities	28
8.10.1	Setting Analyser Date and Time	28
8.10.2	Check for Updates	29
8.10.3	Image Grabber.....	29
9.	Rapidox Data-Logging Software.....	29
9.1	Introduction	29
9.2	Setting up the Data Logger	29
9.3	Running the Data Logger	31
9.4	Auto Date Stamped Files	31
9.5	Live-time Graphing Screen.....	32
9.6	Main Graph Window	33
9.7	Plot Colours.....	33
9.8	Graph Titles and Labels.....	33
9.9	Plot Co-ordinates	33
9.10	Last data point	34
9.11	Using the Cursor	34
9.12	Zooming	34
9.13	Y-Axis Graph Units.....	34
9.14	Oxygen Scale.....	34
9.15	Second Y Axis.....	35
9.16	Loading an Old Run.....	35
9.17	Printing Graphs.....	35
9.18	Data Logging in the Background	35
9.19	Pausing the Data Logging	35
9.20	Changing the Data Logging Parameters Mid-run	36
9.21	Working with Spreadsheets.....	36
9.22	Disaster Recovery.....	36
9.23	Diagnostics.....	37
10.	Troubleshooting	38
11.	Warranty	39
11.1	Conditions of Warranty:	40

1. Introduction

The Rapidox 1100LR oxygen analyser allows accurate oxygen analysis over the range 0.1ppm to 1% O₂ using a special German-engineered ppm electrochemical oxygen cell. This special low range analyser is designed for applications where a traditional zirconia sensor is not suitable. This includes applications where the measurement gas contains VOCs, solvents, fuels, helium or hydrogen.

The analyser provides continuous on-line oxygen analysis, with a typical response time less than three minutes for a response from 1% down to 1000ppm. Below 10ppm response times are considerably longer due to the way electrochemical sensors work.

The analyser is fitted with a special cell holder which allows the reading to stabilise as quickly as possible, and is fully temperature and pressure compensated for enhanced accuracy. The cell is very sensitive to exposure to high concentrations of oxygen, including air, and to prevent damage the unit is fitted with a solenoid valve to keep the cell in the measurement gas at all times; even when switched off.

The analyser contains a powerful diaphragm pump that draws a gas sample at a flow rate set by the user, of between zero and approximately 1.2 litres per minute. An on-board pressure sensor compensates for any pressure changes in the sample gas. Alternatively the pump can be independently switched off and operated under flowing gas conditions.

The analyser includes two fully programmable alarm circuits (volt-free contacts), programmable analogue outputs (0-10V and 4-20mA), easy calibration (using 2 user-selectable gases), RS232/RS485 communications and a full set of communications / data-logging software.

2. Features

- ✓ Continuous gas sampling via powerful internally located pump, which can be independently switched off for the unit to be operated without the pump.
- ✓ Accurate oxygen analysis in hydrogen, helium and gases containing solvents.
- ✓ Measurement range available 0.1ppm to 10,000ppm (1%) oxygen.
- ✓ Accuracy better than $\pm 2\%$ of reading or $\pm 0.5\text{ppm}$, whichever is greater.
- ✓ Easy to calibrate by the user using any two gases.
- ✓ 0-10V and 4-20mA current loop outputs (user programmable).
- ✓ RS232 / RS485 data-output.
- ✓ Windows data logging software with MS-Excel compatible data file output.
- ✓ Programmable alarms with outputs (volt-free contacts) and audible and visual

warnings.

- ✓ Works on any worldwide mains voltage 90-260 Vac.
- ✓ Printer and transport Peli-case options.

3. Specification

3.1 *Rapidox Dimensions & Power Requirements*

Case dimensions: W=250mm; D=263mm; H=150mm. Weight=4kg. Metal carrying handle supplied as an option. Runs on any Worldwide voltage 90-260VAC 50/60Hz. Power consumption is 12W maximum.

3.2 *Accuracy and Resolution*

Sensor response time is typically 180 seconds from 10,000 ppm down to 1000ppm and 5 hours from 10ppm to 1ppm. High accuracy is maintained between calibration points. Accuracy is $\pm 2\%$ of the reading or $\pm 0.5\text{ppm}$, whichever is greater. Maximum resolution is 0.1ppm.

3.3 *Display*

The analyser has a 2-line 16x2, 9mm character, back-lit liquid crystal display (LCD), whose data update rate is user-programmable. The LCD displays up to four significant figures of oxygen (O_2), with a maximum resolution of 0.1ppm. The display notation (auto-percent or ppm) is user selectable.

3.4 *Calibration*

The simple and fully flexible calibration procedure requires two calibration gases. The calibration gas compositions are user-selectable and programmed into the Rapidox via the keypad menu or the RS232 link and configuration software. Factory pre-sets can be reloaded to allow the unit to be 'rescued' from a failed calibration. The Rapidox is calibrated using the keypad on the front panel or directly with the software provided. The LCD changes to calibrate mode to inform the user of progress.

3.5 *Operating Temperature & Pressure*

Gas inlet temperature must not exceed 50°C. The Rapidox unit's normal operating temperature is 5-35°C. Normal operating pressure is 600 to 1750mbar absolute.

Cambridge Sensotec Rapidox 1100LR Oxygen Analyser Instruction Manual

3.6 Outputs

The RS232 serial port (RS485 is available on request) outputs on demand values for oxygen (ppm), the internal temperature and pressure sensor data (temperature in °C, pressure in bar), time (hh:mm:ss) and date (dd/mm/yy). This data can be downloaded and logged using the software provided.

Standard 0-10V and 4-20mA analogue outputs are available on the rear panel for both O₂ and either temperature or pressure (user-selectable), as are two voltage-free reed relay alarm signals. These outputs are fully user-programmable either via the front panel keypad or the supplied configuration software using the RS232 link.

4. Technical Specification

Property	Specification
Supply Voltage	90-260VAC, 50/60Hz
Power consumption	12W (max)
Analyser dimensions	250mm X 263mm X 150mm
Weight	4 kg
Display	16 × 2 character (9mm) back-lit LCD
Warm up time	5 minutes at 20°C
Normal operating temperature	5-35°C
Operating pressure range	600 to 1750mbar absolute
Sensor range	0-10,000ppm (0-1%)
Sensor accuracy	±2% of the reading or ±0.5ppm, whichever is greater
Outputs: O ₂ & temperature or pressure	0-10V (user-programmable) into minimum 5kΩ
O ₂ & temperature or pressure	4-20mA current loop (user-programmable) into maximum 500Ω
Programmable alarms	Relay circuits – fully user-programmable
All data and parameters	RS232 (or RS485) - data streamed on demand
Sample Pump	Mains type diaphragm vacuum pump (variable flow) with on/off switch on rear panel.
Flow Rate	Typically 0-1.2 L.min ⁻¹ in 10 steps
Max. gas temperature at input	50°C
Calibration	Requires 1 or preferably 2 user-selectable gas compositions

Table 1: Technical specification

5. Precautions

Make sure you read and understand these instructions and keep them safe for later

Cambridge Sensotec Rapidox 1100LR Oxygen Analyser Instruction Manual

use. The unit should not be exposed to extreme temperatures $< -5^{\circ}\text{C}$ or $> 60^{\circ}\text{C}$. Normal operating temperature is $5\text{-}35^{\circ}\text{C}$. Avoid direct sunlight. Do not use liquid cleaners, aerosols or solvents to clean the case. Use a damp cloth for cleaning. Do not use this equipment near water. Avoid touching the LCD display as this may cause permanent damage. Make sure the rear ventilation slots and the fan on the rear panel are free of obstruction.

There are no user-serviceable parts in this unit. Do not attempt to repair yourself. Refer all servicing to qualified Cambridge Sensotec personnel.

6. Warning

This unit is NOT designed for use in life support situations. No responsibility can be held for injury or loss of life caused by inappropriate use of this equipment.

7. Rapidox Operating Instructions



Figure 1: Rapidox 1100LR front panel. Numbers are referred to in the text.



Figure 2: Rapidox 1100LR rear panel. Numbers are referred to in the text.

7.1 The Rapidox Analyser - Menu System

All of the user-programmable functions are accessed via a menu system which is controlled using the front panel Keypad (2). To access the menu press the ENT button and to escape and return to the operating screen press ESC at any time. The menu system flow chart is shown in Appendix 1 at the back of the manual.

7.2 Getting Started

Ensure that the Rapidox analyser is located away from extreme heat and dirt environments. Plug the unit in to a suitable supply (noting the information on the serial sticker and using the power cable supplied) using the rear power socket (8). Make sure that the cooling fan (9) is not obstructed during operation.

Turn the unit on using the red power switch on the front (5). The LCD (1) will display the serial number and firmware version for a few seconds before measurements begin. The sensor will take approximately five minutes to stabilise. The LCD display will show the oxygen reading and either the temperature, pressure or date and time (user-selectable). The symbol AL1 or AL2 may appear to the bottom right of the LCD if the alarm system is enabled and an alarm condition applies.

Push the gas sample tube (6mm OD/4mm ID) into the GAS IN (3) quick release connector. Repeat for the GAS OUT (4) connector should an outlet tube be required. The pump will draw gas at a flow rate depending on the value set either in the software or from the menu. The default setting is OFF.

Cambridge Sensotec Rapidox 1100LR Oxygen Analyser Instruction Manual

Allow five minutes for the Rapidox to stabilise fully. If the sensor has been exposed to air or the gas composition is greater than 3% oxygen then the message "O/Range" will appear on the display. Below 3% oxygen but above 1% the display will read the maximum value of 10500ppm (or 1.05%) but will flash until the gas mix goes below 10500ppm, when normal readings will begin. Flush the analyser with your measurement gas and wait a few moments for the readings to come on scale.

7.3 Pump Control

The flow rate of gas drawn into the analyser can be controlled using the menu option 2 "Set Pump Flow". The unit is supplied with the flow rate set to OFF. If you wish to change the flow rate press ENT and select menu option 2. Use the UP & DOWN arrows to change the value from OFF to 100% in 10% increments. 100% equates to approximately 1.5 litres per minute. Once you have selected the desired flow rate, press ENT to confirm your selection. If you do not press ENT, the pump will revert to the previous rate when the unit exits the menu system. When using the unit with a pressurised (flowing) gas source the pump can be left switched off.

7.4 Menu Access / Passwords

The analyser has an option to set a password that will restrict access to the menus. The password menu is disabled by default in the factory. If you wish to password protect the analyser press ENT and scroll down to the PASSWORD option (menu option 12). Pressing ENT again will ask you for the default password which is "0000". Enter this using the UP and DOWN arrows. Once the password has been entered successfully you can choose between ENABLE and DISABLE in the menu using the UP and DOWN keys.

The other option is to CHANGE the password to a new value. The password must be 4 digits long and can be any combination of numbers from 0000-9999. Make sure that the new password is noted down!

If the password function has been enabled then in the future each time the menu system is accessed, the password prompt will display. After the correct password is entered then the full menu will be accessible. You can make as many changes as you want to the menu options and only press ESC once you have finished. Pressing ESC takes you out of the password protected area and you will have to re-enter the password to go back in again.

If the password has been forgotten please contact Cambridge Sensotec who will advise you on how to recover it.

7.5 Rapidox Calibration

Once the unit is at temperature it may be necessary to calibrate the sensor. Full

Cambridge Sensotec Rapidox 1100LR Oxygen Analyser Instruction Manual

calibration is a simple procedure requiring only one or two gases. The two gas values are user-selectable and can be changed via the front keypad (2) or the communications software described in section 8, and the calibration values can be stored on file for later use. It is suggested that one cal gas is set between 1000 and 10,000ppm and the other cal gas is set between 10 and 1000ppm. Below 10ppm the sensor takes many hours to stabilise so calibration could become very slow. Factory calibration is done at 10,000ppm and 100ppm.

The procedure is as follows:

- 1) Bearing in mind the points made above, decide which two gases you are going to use for calibration. If you are constantly working at a particular range of compositions then it would be wise to obtain small cylinders of calibration gas with analysis certificates. Cambridge Sensotec can supply these. Press the ENT button on the front panel keypad (2) to access the menu system. Using the UP and DOWN arrow buttons scroll to menu option 1 "Calibrate" and press ENT again to enter the calibration menu. Use the UP and DOWN arrows to select "O₂ High" or "O₂ Low" and press ENT to proceed. The top line of the display shows the current calibration gas stored and the bottom line of the display shows the prompts. If the gas value is not what you require you can edit the value (in ppm scientific notation) using the up and down and right arrows on the keypad. The cursor flashes underneath the digit to edit. For example 1000ppm should be entered as 1.000E+03ppm. Note that you can not go backwards to edit a digit to the left of the cursor. Instead keep pressing the RIGHT button and the cursor will wrap around back to the beginning. Alternatively press ESC to start again. Press ENT when you are ready to proceed.
- 2) The sensor needs to be exposed to the first calibration gas from a cylinder of known composition. For accurate calibration it is important to allow sufficient time to pass to flush the sensor properly. Wait for the top line of the display (1) to become stable. The time this takes depends on the oxygen concentration of the gas: for 1% oxygen about 5 minutes should suffice, but for 100ppm it may be necessary to wait for about 30 minutes. To complete the calibration press and hold the ENT button for two seconds. During this time you will see a bar graph progress across the lower display. The analyser will then recalibrate and display "O₂ Calibrated" and then return to normal run mode. The display will now correctly read the value of the first calibration gas. Note that if the ENT button is released before two seconds have elapsed, the recalibration will be aborted and when the analyser eventually returns to run mode it will use the existing calibration.
- 3) Note that the analyser should ideally be calibrated at normal ambient pressure and at the temperature at which it will be used. If the pressure correction mode is set to AUTO then it is still possible to perform an accurate calibration at pressures other than ambient. If the gas temperature is significantly different from the ambient temperature, allow the gas to flow for sufficient time for the sensor temperature to stabilise fully before calibrating.

- 4) The analyser predicts the correct signal from the sensor during calibration and if this is outside the range of expected values then the display will flash and display “G?” to warn you that either the cal gas flowing over the sensor is different to the value you have programmed OR the sensor may be old and approaching the end of its life. Check before proceeding!
- 5) To calibrate using the second calibration gas, repeat the procedure from 2 but this time press ENT followed by the UP or DOWN button to scroll through to the “O₂ Low” screen. Flush the sensor chamber with the second calibration gas allowing several minutes for the new gas to flush through. Wait for the display to become stable before pressing the ENT button for two seconds. The analyser will then recalibrate and display “O₂ Calibrated” and then return to normal run mode. The display will now correctly read the value of the calibration gas.
- 6) The analyser is now correctly calibrated and will read accurately between these two calibration points. Note that this procedure can also be performed remotely using the software described in section 8.
- 7) If at any time, you encounter difficulties and wish to restore the machine to its factory set calibration, use the configuration software provided and load the original factory settings (described in section 7.17 below). Each machine is provided with a unique file that contains the factory settings. This is located on the CD-ROM provided and is copied onto your PC during the installation process.
- 8) Note that the two calibration points are independent of each other so you can calibrate the analyser in any order you desire. However please note that ‘O₂ High’ must always be greater than ‘O₂ Low’. Typically the factory settings are ‘O₂ High’ = 10000ppm and ‘O₂ Low’ = 100ppm.

NB You must always perform a FULL calibration to achieve good accuracy.

7.6 Alarms

The Rapidox is fitted with two independent and fully programmable alarm relay outputs, which can be programmed to be either normally open (N/O) (closes on alarm) or normally closed (N/C) (opens on alarm). You have the option of assigning each alarm to the oxygen, pressure (internal) or temperature sensors, as well as enabling the alarm relay circuits, enabling an audible buzzer and enabling a visual warning on the screen.

The alarms can be programmed by the user via the keypad (2) on the front panel or using the software provided (see section 8.5.3). To change the alarm settings scroll down the menu to option 3 “Set Alarms” and press ENT. Now use the UP & DOWN arrows to select “Alarm 1” or “Alarm 2” and press ENT. The next screen shows the message “Assign To:” followed by the currently assigned parameter.

Cambridge Sensotec Rapidox 1100LR Oxygen Analyser Instruction Manual

Use the UP and DOWN arrows to select O₂, temperature (of the gas) or pressure depending on which measurement you want the alarm to work with, and press ENT to proceed. The default is O₂.

The next settings configure the behaviour of the alarm. Use the UP & DOWN arrows to select ON or OFF for the following parameters:

1. **OUTPUTS:** This enables the rear panel relay outputs when ON is selected
2. **AUDIBLE:** This enables or disables the audible buzzer inside the unit which will sound in an alarm condition
3. **VISIBLE:** This enables or disables warning messages on the LCD screen on the front of the Rapidox. During an alarm condition either “AL1” or “AL2” (or a combination of both) will flash at the bottom right hand corner of the display.
4. **POLARITY:** This determines whether you are setting a rising or falling alarm. Use the arrows to change the direction of the alarm to up or down. A rising alarm means that the alarm will be silent at values below the set-point but as soon as the value rises above the set-point the alarm will be triggered
5. **SETPOINT:** The current alarm set-point is displayed in scientific notation with a flashing cursor under the first digit. Use the UP & DOWN arrows to change the digit and the RIGHT arrow to progress until the correct value is displayed. When done, press ENT to proceed to the next setting.
6. **CONTACTS:** The relay outputs can be set to either normally open (N/O) or normally closed (N/C). The factory default is N/O, meaning the contacts will close when an alarm condition occurs. Press ENT to save all the above settings for the selected alarm.

Alarm 2 can be set in exactly the same way as described above and both alarm circuits are completely independent of each other. Note that you must programme all the parameters for each alarm for the settings to be saved. The bottom line of the LCD will display “Alarm x set” (where ‘x’ is the selected alarm channel) to confirm that the settings have been saved.

The alarm circuit relays are accessed via the terminal block on the rear panel and are clearly labelled. Alarm 1 is assigned to the terminals labelled “Alarm High” and Alarm 2 is assigned to the terminals labelled “Alarm Low”. The relay circuit is rated at 24V 0.5amps maximum.

The alarm limits for oxygen are set to a minimum of -100ppm and a maximum of 30,000ppm. Under certain conditions (e.g. the sensor becomes disconnected) the Rapidox will set the alarm channel to OFF to prevent false alarms, and the relay contacts for the affected channel will go to the programmed N/O or N/C setting. For more information please refer to Table 2 in section 7.7 below.

7.7 Analogue Outputs

The standard industrial analogue outputs (0-10V and 4-20mA) for both oxygen

Cambridge Sensotec Rapidox 1100LR Oxygen Analyser Instruction Manual

and pressure are accessible via the terminal block (6) on the rear panel. Note that the ranges of the 0-10V and 4-20mA are tied together so changing one alters the other. In the case of oxygen, the outputs are factory set to provide a linear response in the range 0-10,000ppm that will cover most applications. However the lower and upper values are fully user-programmable using the keypad (2) or the software provided (section 8). A more details description is given below:

The linear oxygen output mode setting produces an output that is scaled linearly between 0 and 10V (or 4 and 20mA). So, for example, if the scale is set 0V = 0ppm (0%) O₂ and 10V = 10,000ppm (1%) O₂ then 5V would indicate an oxygen reading of 5000ppm (0.5%) O₂. The scaling of this example is shown in the following plot, from which other intermediate values can also be read.

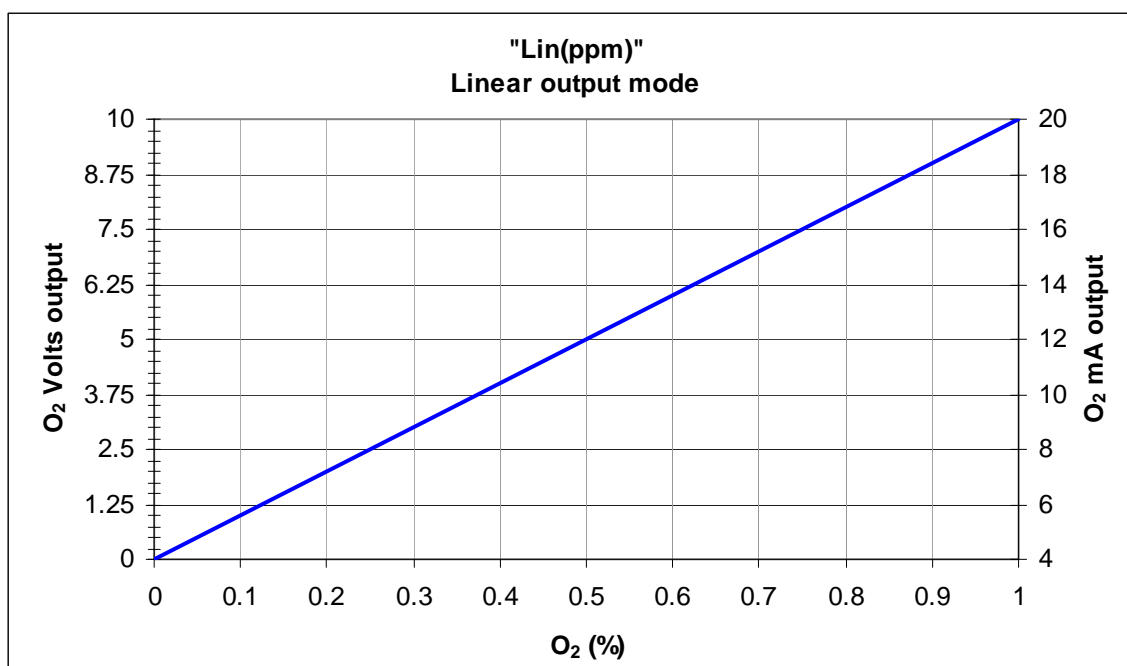

Figure 3: Graph showing the linear output mode option for oxygen

The following general formulae can be used to calculate the oxygen from the voltage or current outputs when set to the linear output mode:

Output type	Formula for calculating oxygen from analogue output signal
0-10V	$O_2 = V_{out} / 10 * (O_{2H} - O_{2L}) + O_{2L}$
4-20mA	$O_2 = (mA_{out} - 4) / 16 * (O_{2H} - O_{2L}) + O_{2L}$

Where: O_{2L} = user setting of oxygen for 0V or 4mA output ¹
 O_{2H} = user setting of oxygen for 10V or 20mA output ¹
 V_{out} = the measured voltage output in volts
 mA_{out} = the measured current output in mA

¹ O₂, O_{2L} and O_{2H} must all be in the same units.

To modify the oxygen analogue output range scroll down the menu to no.3 “Set Outputs” and press ENT. You can now edit the lower and upper values in exactly the same manner as described in 7.5 for setting the cal gas values. Once

Cambridge Sensotec Rapidox 1100LR Oxygen Analyser Instruction Manual

programmed the new values remain in the memory until they are edited again in the future.

To select and modify the auxiliary outputs (pressure) scroll down to menu option 3 “Set Outputs” and press ENT four times. Use the up and down arrow buttons to program the pressure scale and press ENT. The permissible range is -2000mbar to +2000mbar.

During initial warm up of the Rapidox when the display reads the serial number the output sent to the rear terminal for oxygen will stay at 2mA (1V) which is the standby signal. If at any stage a sensor becomes disconnected internally, or the signal exceeds the measurable range for that sensor, then the display will indicate there is a fault and the outputs will change to 1mA (0.5V) which is the sensor fault signal. This will recover as soon as the sensor is reconnected and the fault cleared. Additional current and voltage signals are provided by the analyser to give an indication of various conditions and these are described in Table 1 below, together with the status of the alarms during the condition:

O₂ Analogue Outputs		Description	Explanation	Alarms⁽⁴⁾
Current⁽²⁾ (4-20mA)	Voltage⁽³⁾ (0-10V)			
1mA	0.5V	Fault	There is a sensor fault on the oxygen sensor, and/or the temperature sensor has a fault condition, and/or the pressure mode is set to automatic (pressure compensation active) and the pressure sensor has a fault condition.	De-activated
2mA	1V	Start up	The analyser is still initialising.	De-activated
2.5mA	1.25V	Sensor under range	The sensor reading is under range.	Active
3mA	1.5V	Sensor over range	The sensor reading is over range.	Active
3.5mA	1.75V	Sensor operating out of specification	The sensor reading is in range but the temperature sensor reading is out of range, and/or the pressure mode is set to automatic (pressure compensation active) and the pressure sensor is out of range.	Active
4 to 20mA	0 to 10V	Normal operating output	The O ₂ sensor and associated ⁽¹⁾ sensor(s) are operating normally and readings are in range.	Active
Aux Analogue Outputs		Description	Explanation	Alarms⁽⁴⁾
Current⁽²⁾ (4-20mA)	Voltage⁽³⁾ (0-10V)			
1mA	0.5V	Fault	The assigned sensor has a fault.	De-activated
2mA	1V	Start up	The analyser is still initialising.	De-activated
2.5mA	1.25V	Sensor under range	The assigned sensor reading is under range.	Active
3mA	1.5V	Sensor over range	The assigned sensor reading is over range.	Active
4 to 20mA	0 to 10V	Normal operating output	The assigned sensor is operating normally and readings are in range.	Active

Table 2: Analogue output settings and alarm status for certain conditions

Notes:

- 1 “Associated” sensors are the temperature sensor and the pressure sensor (when pressure mode is set to automatic).
- 2 The current outputs are active self-powered outputs - they are not loop powered.
- 3 The voltage (0 to 10V) outputs produce non-zero voltages during start-up, fault and over/under range conditions - if 1V to 5V outputs are required, with these conditions indicated by corresponding voltages between 0V and 1V, the current outputs can be used, with a 250 Ohm load resistor.
- 4 Alarms are de-activated during start up initialisation, and when a fault condition occurs on the assigned sensor.

7.8 *Setting the Display Units*

The notation used by the display is fully programmable to suit your needs using the keypad (2) or the software provided (section 8.5.1). The following options are available to you:

1. **Oxygen:** The oxygen reading can be displayed in percent (e.g. 1.000%), or ppm (e.g. 1.0ppm) If percent is selected the Rapidox will display oxygen as a percentage down to 0.01% and in ppm below this value.
2. **Temperature:** The reading can be displayed in °C or °F
3. **Pressure:** The reading can be displayed in mbar, bar, psi, torr or kPa.

To programme these options scroll down to menu item 5 “Set Units” and press ENT. Use the ENT key to progress through the list and the UP & DOWN keys to select the required units. Once selected press ENT to store and return to run mode.

7.9 *Setting the Display Options*

The user can select the LCD refresh rate and the format of the line 2 display using the keypad or the software provided. Scroll down the menu to option 6 “Display Setup” and press ENT. Use the UP & DOWN arrows to select either the LCD refresh interval or Line 2 Options:

1. **Line 2 Options:** The information displayed on line 2 of the LCD can be chosen by the user. The options are Pressure, Temperature, None, Date/Time or alternating Temperature and Pressure. Use the UP & DOWN arrows to select the required option and press ENT to store and return to the main menu.
2. **LCD Refresh Interval:** The display update interval can be selected from 0.1 to 1.5 seconds. The current setting can be edited using the same method as described previously. Once edited press ENT to store and return to the main menu. The default setting is 0.3 seconds.

7.10 *Internal Pressure Sensor*

The Rapidox 1100LR is fitted with an internal absolute pressure sensor which monitors small changes in pressure and vacuum inside the sensor head. The pressure will normally be ambient absolute (e.g. 1013 mbar) under normal operation but if the unit is being fed by a gas cylinder or connected to an apparatus under partial vacuum then the pressure will change and this will have a direct effect on the oxygen partial pressure and the sensor reading. You have the option of displaying the pressure reading on the LCD display (1). Select no. 6 “Display Setup” and press ENT. Select “Line 2 Options” using the UP & DOWN arrows and press ENT. You can set the display to read Pressure or None. Select Pressure and press ENT. The display will now show the absolute pressure reading from the internal sensor. If you want to view different units select no. 5 “Set

Units” from the menu and press ENT three times to reach the pressure screen. Use the UP & DOWN arrows to select mbar, bar, torr, psi or kPa and press ENT. The display will now show the pressure in the selected units.

7.11 Pressure Mode

The user has the option of using the reading from the internal pressure sensor to automatically correct for changes in gas pressure and hence oxygen pressure. To access this function scroll down to menu option 7 “Pressure Mode” and press ENT. The desired mode can then be selected using the UP & DOWN arrows and pressing ENT to store and proceed. The two modes available are:

- 1. None:** If this mode is selected then there is no pressure correction performed on the oxygen reading. The pressure and oxygen sensor act independently, and the oxygen reading will vary with the gas pressure.
- 2. Auto:** This is the factory default setting. If the Auto mode is selected then the Rapidox 1100LR uses the reading from the internal pressure sensor to correct the oxygen partial pressure and maintain an accurate concentration reading.

7.12 Setting the Baud Rate

If you are using the software for data logging you can choose the communications speed (Baud Rate) by scrolling down the menu to option 8 “Set Baud Rate” and using the UP & DOWN arrows to select 9600, 57,600 or 115,200. Press ENT button again to store and return to normal operation. The default factory setting is 115,200. However if you are using an older PC you can decrease this to 57,600 or even 9600 to improve the reliability of the software and data communications.

7.13 RS232 / RS485 Port

The data communications port is normally configured to RS232. It is also possible to factory set the data communications port to RS485. Once configured at the factory it is not possible to change unless the unit is returned to Cambridge Sensotec Ltd.

Data from the Rapidox is sent on demand to the 9-way 'D' type socket (7) on the rear panel and can be read using a simple terminal programme such as 'HyperTerminal' in Windows, or with the user's own custom software. Alternatively a simple and convenient data logger programme is included with the supplied software and is described in section 9 below.

7.13.1 RS232 Protocol

Rapidox data can be read from the RS232 port at the back of the unit. The default

Cambridge Sensotec Rapidox 1100LR Oxygen Analyser Instruction Manual

RS232 configuration is 115200-8-N-1, as shown in this example for COM1:

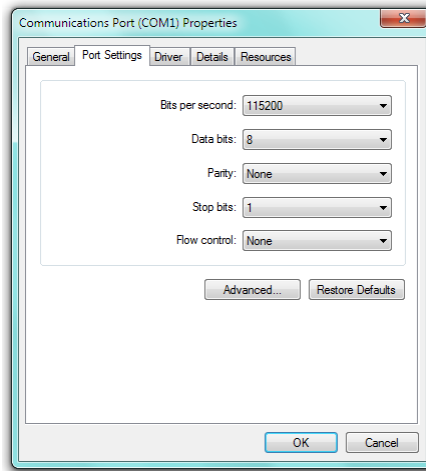

Figure 4: Rapidox default COM properties box

Alternatively, the baud rate can be reduced to 57,600 or 9600 via the “Set Baud Rate” menu item, using the front panel keypad on the Rapidox. This setting is stored in EEPROM.

Connection: Connect to RS232 socket at the back of the Rapidox using a 9 way D-type plug. Signals are as follows:

Rapidox D-type Socket:	PC/PLC:
Pin# 2 = Data Out	→ Data In (RX)
Pin# 3 = Data In	← Data Out (TX)
Pin# 5 = Common/Gnd	-- Common/Gnd

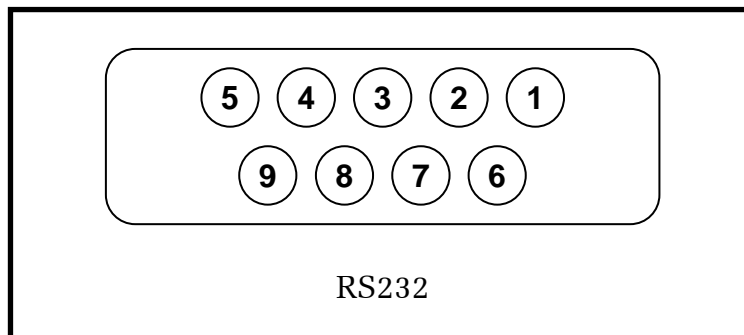

Figure 5: Rapidox RS232 pin configuration

All other pins (1,4,6,7,8,9) = Don't care

Reading Data: Data is read using command “D”. Send the single character “D” to the Rapidox. The Rapidox replies with one of the following responses. All valid responses end with [CR] & [LF] (where [CR] = ASCII 13 and [LF] = ASCII 10).

Response: !Initialising[CR][LF]

Cambridge Sensotec Rapidox 1100LR Oxygen Analyser Instruction Manual

Meaning: Rapidox is still initialising

Response: !User setup active

Meaning: The configuration menu has been activated via the front panel keypad. The menu will automatically time out 30 seconds after the last key was pressed, or press the keypad's ESC key to return immediately to normal run mode.

Response: !Possible sensor fault

Meaning: The sensor has failed to reach operating temperature within 10 minutes from power up. This may be due to the age of the sensor, or because a high thermal conductivity gas is being used.

Response: !No sensor or sensor fault[CR][LF]

Meaning: Sensor is not connected, or there is a fault in the sensor

Response: d9.959E+04,1.426E+02,2.000E-03,2.610E+01,23:19:40,14/11/10,ALM1&2,0[CR][LF]

Meaning: "d" means data is being sent
"9.959E+04" is Oxygen reading in ppm
"," = data separator
"1.426E+02" is Oxygen sensor reading in mV
"," = data separator
"2.000E-03" is the internal pressure sensor reading in bar (gauge)
"," = data separator
"2.610E+01" is temperature sensor reading in °C
"," = data separator
"23:19:40" is Rapidox time – ignore this
"," = data separator
"14/11/10" is Rapidox date in DD/MM/YY format – ignore this
"," = data separator
"ALM1&2" means that both alarm conditions 1 and 2 exist **
"," = data separator
"0" is an integer indicating a sensor fault code: 0 = no faults
[CR] = ASCII 13 (Carriage Return character)
[LF] = ASCII 10 (Line Feed character)

** If no alarm conditions exist, this data is empty, so the response would look like:

d9.959E+04,1.426E+02,2.000E-03,2.610E+01,23:19:40,14/11/10,,0[CR][LF]

Response: ?

Meaning: "D" command was not recognised. Try to send it again.

7.13.2 RS485 protocol

Please contact Cambridge Sensotec for further information on this feature.

7.14 *Setting the Date & Time*

The date and time can be programmed either using the software programme or from the menu on the analyser itself. Scroll up to menu option 9 “Set Date/ Time” and press ENT. The current date is displayed as e.g., ‘Date: dd/mm/yy’ with the flashing cursor under the ‘yy’ parameter. Note that the exact format will depend on the country you are in and the regional options setting of the PC you have used to connect to the analyser. So for example in the USA you would see ‘Date: mm/dd/yy’ instead. The prompts at the bottom of the screen indicate what to do: use the UP and DOWN arrow keys to change the value above the flashing cursor and press ENT to progress. The cursor always starts under the year value as this will dictate how the months behave e.g., during a leap year.

Once the date has been set, the display will change to show ‘Time: hh:mm:ss’ with the flashing cursor under the ‘hh’ parameter. Once all the values are programmed correctly press ENT to return to the run-mode screen. Note that if you reprogramme the date and time using the software then this will overwrite any changes you have just made and will use the current date and time of the PC.

7.15 *Replacing the Oxygen Sensor*

The oxygen sensor fitted to the 1100LR has a life expectancy calculated in terms of how much electrolyte is remaining in the cell. The electrolyte is a liquid that slowly dries out over time. This especially happens in dry gases (most low O₂ gases will probably be like this) where it is normal to get 12 to 18 months life from a cell. In humid applications this may be as much as five years however so these following warnings are just a guide. The cell is held in a metal housing and it is possible to replace it yourself. Please ask Cambridge Sensotec for advice. Once the cell is replaced go to menu option 2 “New Sensor” and press ENT whereupon you will see a message saying “Fit New Sensor in X days”, where X is a number showing how many days are remaining. The next screen says “New Sensor?” If you have just replaced the sensor then press ENT to confirm or ESC to leave the menu. This will give a message confirming “New Sensor Confirmed” and the on-board countdown clock will set itself to 365 days, based on the current date.

Note that when the sensor countdown is <60 days to zero the start up screen will display “Fit New Sensor in X days” for 1.5 seconds as a reminder. At <30 days the start-up screen message will hold for 3 seconds and will be accompanied by two beeps as an additional reminder.

Finally, for the benefit of units that are never switched off, when the countdown clock reaches <30 days a flashing “*” will appear next to the “O₂” on the display. If this is ignored and the countdown reaches 0 the “*” will no longer flash. To remove this warning, replace the sensor and reset the countdown using menu option 10.

7.16 *Printing*

If you have purchased the printer option then you can print data from the analyser straight on to thermal paper. Simply connect the printer to the serial socket on the rear of the Rapidox and make sure the printer is switched on (battery and mains versions are available). To print the live values on the LCD at any time simply press the RIGHT arrow button on the front panel. Each press of the button will print out the serial number followed by the data in a tabbed format followed by a blank line. If the button is held down, the printer will keep printing data (but not the serial number).

When the printer is first connected or turned on, a “start-up” message like the one displayed on the LCD when the Rapidox is switched on will be printed, and will look like this:

```
Cambridge  
Sensotec Ltd  
Rapidox 1100LR  
Oxygen Analyser  
S/N: 2100942  
FW v 01.03.03.01
```

7.17 *Load Defaults*

If you make a mistake while programming the Rapidox it is possible to restore the machine back to its factory calibration and settings by loading the unique original configuration file that is supplied on your software CD-ROM. This can be accessed using the software provided (please see section 8.4 for further details).

Alternatively, you can reset to ‘generic’ factory defaults directly from the front panel keypad. Press ENT to enter the user setup menu and select menu option 11 “Load Defaults” and press ENT to proceed. The next screen will say “Load Defaults?” with the prompt to press and hold ENT for 2 seconds to confirm. To complete this press the ENT button until the bar graph has completed and the screen says “Defaults Loaded”. This will give you all the basic settings that are factory set. You will now need to re-calibrate the sensor and check all the settings are suitable.

8. Rapidox Software Instructions

8.1 *Software Installation*

It is possible to programme a range of variables to the Rapidox using an RS232 (or RS485 if configured) link with a PC running MS-Windows (all versions) and the supplied Rapidox software. The software is installed automatically by inserting the Rapidox CD into the CD-ROM drive. If auto-installation does not start then you can click the Windows START button and select RUN. Type 'X:\setup.exe' where X is the drive letter of your CD. Alternatively access the CD from Windows Explorer or the 'My Computer' icon on your desktop, and double-click on the 'Setup.exe' programme. Follow the on-screen instructions to install the programme onto the hard drive. Once installed, you can access the programme by clicking START - PROGRAMS – Rapidox Software.

The software has been tested successfully on most language machines including Chinese, Korean & Japanese and all current versions of Windows operating system. We do not recommend the use of Vista as connecting USB to serial converters to this operating system can be problematical at best.

Note that software is 'regionally aware' and will therefore accept and display data using the decimal separator that is set in the PC's Regional Settings in the Control Panel. For example, in the UK or US, you might enter the value 2.5 - in continental Europe this would normally be entered as 2,5 assuming the PC's Regional Settings have been set up to use ',' as the decimal separator.

8.2 *Getting Started*

Make sure that the Rapidox is connected to a free serial port on the rear of your computer and is powered on. These will nearly always be COM1 or COM2 but the software will scan through the ports until it finds the Rapidox. The analyser must be switched on for this to succeed and while you are communicating with it. On start up the software will locate the Rapidox and display the following page:

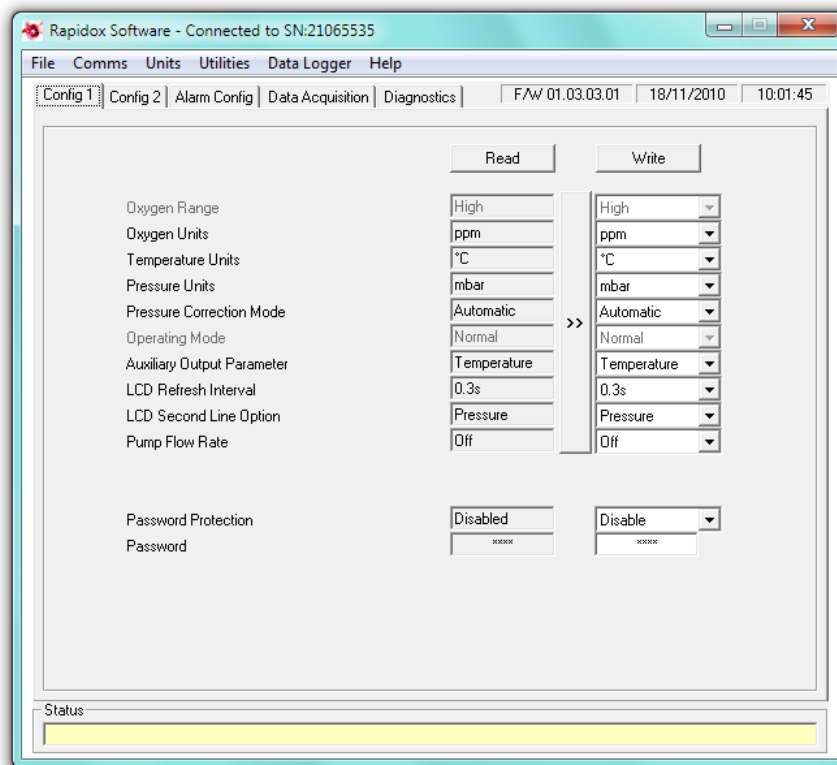

Figure 6: Configuration 1 page. Note the actual values used may differ from those shown above.

The yellow 'Status' box at the bottom will display confirmation that the Rapidox was found and the result of the last action, or any error messages if there is a problem with communication. If you experience problems check that your serial cable (supplied) is correctly fitted to a valid serial port. Also check the status of your COM port settings in Device Manager accessed by clicking START – Settings - Control Panel. If your PC does not have a serial port, you can use a USB to RS232 adapter – please contact Cambridge Sensotec if you would like advice about selecting one.

8.3 On-Screen Help

You can access the on-screen help facility at any time by clicking on the 'Help' menu on the menu bar and select the 'Contents' option, or alternatively press F1.

8.4 Configuration Page

The configuration page is split into three, and you can switch between them by clicking on the tabs labelled 'Config 1', 'Config 2' or 'Alarm Config'. Each page allows the user to reprogramme an array of parameters used by the Rapidox. Once written to the Rapidox, the new parameters remain permanent until overwritten.

To read the current configuration stored in your Rapidox select 'Read Analyser Configuration' from the 'File' menu, or click the 'Read' button on any of the

'Config' pages. Note that the entries in the boxes on the RHS (under the 'Write' button) will turn red if the value is different to that just read and a red asterisk will appear next to the 'Write' button to warn you that a change has been made. The left-hand set of grey text fields ('read fields') will be updated with the current configuration data. To save this information (e.g., if several people share the same instrument) click the long copy ('>>') button (between the 'Read' and 'Write' columns) on any of the 'Config' pages in order to transfer the data into the edit boxes, select 'Save Configuration as' from the 'File' menu and choose a filename. This data set can be subsequently reloaded at any time by selecting 'Load Configuration File' from the 'File' menu and then selecting the folder where the configuration files have been stored.

If at any time you wish to restore the Rapidox to its factory default settings select 'Default Configuration' from the 'File' menu to load these values. The software will search for a unique '.rxc' file which is loaded onto the PC during the software installation. The filename is 'XXXXXXX.rxc' where 'XXXXXXX' is the unit's serial number, which can be found on the rear of the machine. The original copy of this file is also on the CD-ROM that came with the analyser. Normally this file is automatically copied to the main Rapidox folder, but if the software cannot locate it then it will ask you for the serial number to help it search. The 'rxc' file will be loaded into the 'Write' columns, and the software will then automatically perform a 'Read' to update the data in the 'Read' columns in order to highlight the differences between the current configuration (in the 'Read' columns) and the settings from the file (in the 'Write' columns). If you wish to proceed with the reconfiguration simply click any of the three 'Write' buttons to reprogramme the Rapidox.

The right-hand set of white editable text fields ('write fields') is used to enter new values to be programmed into the Rapidox. The values in these fields can either be entered manually, or copied across from the 'read fields' by clicking the vertical '>>' (copy) button, and then edited as required, however greyed boxes under the 'Write' buttons are not editable as they contain calibration data; they can only be changed by copying data across from the 'Read' fields. Note that when you click on the copy button all three 'Config' pages are updated at the same time and there is no need to repeat the action when you toggle to another page. Alternatively, you can load saved configuration data by selecting 'Load Configuration File' from the 'File' menu and selecting the required file. In order to programme the analyser select 'Write configuration to analyser' from the 'File' menu, or click the 'Write' button on any 'Config' page.

8.5 Reconfiguring the Analyser

The on-screen edit boxes contain variables that can be reprogrammed into the Rapidox in exactly the same manner as using the front panel keypad. For a full description please refer to the relevant section in this manual.

The user can choose whether to use ppm or percent notation to edit the O₂ text boxes, where appropriate, by selecting the 'Units' menu and clicking on 'Percent'

or 'ppm'. To access a field, either click inside it or use the TAB key to scroll through the fields. The field parameters are as follows:

8.5.1 Config 1 Screen

- 1) **Oxygen Range:** Not available for the Rapidox 1100LR
- 2) **Oxygen Units:** See Section 7.8 for a full description. Use the drop down box to select AUTO% or PPM. The default setting is AUTO%.
- 3) **Temperature Units:** See Section 7.8 for a full description. Use the drop down box to select °C or °F.
- 4) **Pressure Units:** See sections 7.8 for a full description. Use the drop down menu to select MBAR, BAR, PSI, TORR or KPa as the unit for pressure measurement. The default setting is MBAR.
- 5) **Pressure Correction Mode:** See section 7.11 for a full description. Use the drop down menu to select NONE or AUTOMATIC. The default setting is AUTOMATIC.
- 6) **Operating Mode:** Not available for the Rapidox 1100LR
- 7) **Auxiliary Output Parameter:** Use this menu to select either PRESSURE or TEMPERATURE as the parameter sent to the auxiliary output on the rear panel of the analyser.
- 8) **LCD Refresh interval:** Use the drop down menu to select a refresh rate for the LCD (min 0.1, max 1.5 sec). The default is 0.3 seconds.
- 9) **LCD Second Line Option:** See section 7.9 for a full description. Use the drop down menu to select Pressure, Temperature, None, Date/Time or alternating Temperature and Pressure.
- 10) **Pump Flow Rate:** See section 7.3 for a full description. Use the drop down menu to select a pump flow value from 10 to 100% or OFF.
- 11) **Password option:** See section 7.4 for a full description. The password is factory disabled and set to '0000'. Use the drop down menu to enable or disable the password feature and the password box '****' can be used to enter a new password. Note that you will be prompted to enter the original password if you wish to make changes to the password or its status.

8.5.2 Config 2 Screen

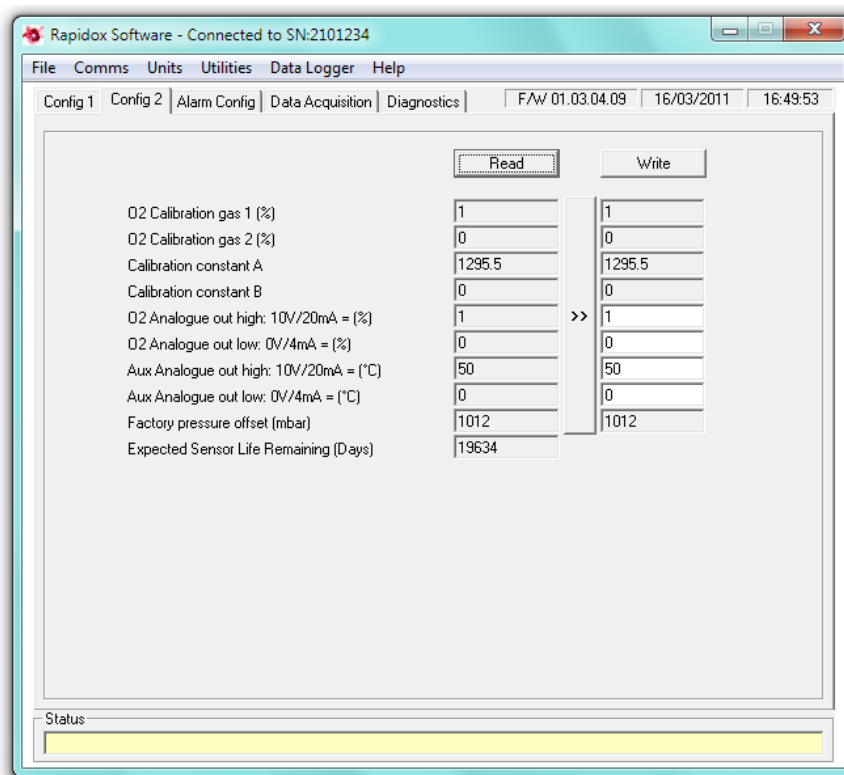

Figure 7: Configuration 2 page. Note the actual values used may differ from those shown above.

- 12) **Calibration Gas 1, 2:** These boxes are greyed out in this version and the data is for information purposes only. If you want to change the current calibration gas then follow the procedure given in section 8.7.
- 13) **Calibration Constant A & B:** These boxes contain the calibration constants that the Rapidox calculates automatically when you perform a calibration. You will see that they change each time you perform a new calibration.
- 14) **O₂ Analogue Outputs (0V/4mA & 10V/20mA):** Use these two boxes to set the High and Low oxygen values for the analogue outputs (6) on the rear panel. For example if you want 0V/4mA to represent 1ppm and 10V/20mA to represent 1000ppm then enter these two values into the appropriate boxes. The value can be entered either in % or ppm depending on the units selected. The default values are 10000ppm for the high setting and 0ppm for the low setting.
- 15) **Auxiliary Analogue Outputs (0V/4mA & 10V/20mA):** Use these two boxes to set the High and Low auxiliary values for the analogue outputs (6) on the rear panel. This can be set to Pressure or Temperature. For example if you want 0V/4mA to represent 0°C and 10V/20mA to represent 50°C (for temperature) then enter these two values into the appropriate boxes. The

units are determined automatically according to the sensor type.

- 16) **Factory Pressure Offset:** This value is preset in the factory to fine tune the on-board pressure sensor and is just shown for information purposes. Please ignore this value as it is fixed for the life of the analyser.
- 17) **Expected Sensor Life remaining:** See section 7.15 for a full description. This value is for information purposes only and can not be adjusted. It shows the number of days remaining from a countdown starting at 365 days. Once the countdown reaches 0 the sensor should be replaced although this does depend to a degree on level of use and the humidity of the gases exposed to the sensor.

8.5.3 Alarm Config Screen

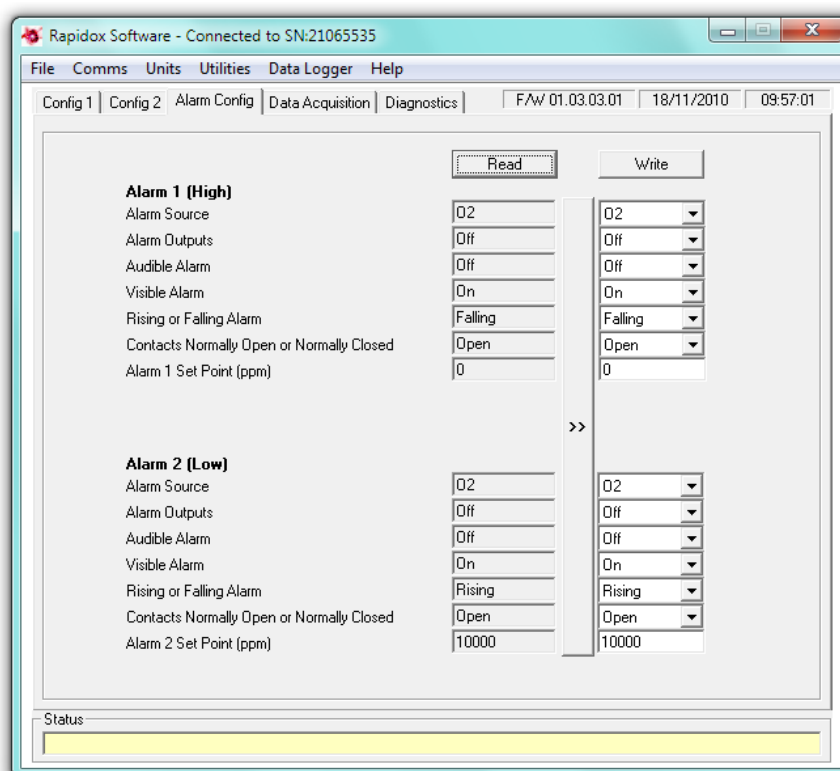

Figure 8: Alarm configuration page. Note the actual values used may differ from those shown above.

- 18) **Alarm Source:** Use the drop down box to assign a detector to the alarm. If you want the alarm to be based on oxygen readings select oxygen from the drop down list. The choices are: oxygen, pressure or temperature.
- 19) **Alarm Outputs:** This option enables or disables the alarms on the rear panel (labelled Alarm High +/- and Alarm Low +/-). Make sure these are enabled if you wish to use the signals from the alarm circuit.
- 20) **Audible Alarm:** This option enables or disables the audible buzzer fitted to

the Rapidox internally. When an alarm condition occurs the buzzer will emit a continuous noise to alert the operator.

- 21) **Visible Alarm:** This option enables or disables the visual warning on the front LCD. When enabled and an alarm condition occurs the message “AL1” or “AL2” (or both) will flash in the lower right hand corner.
- 22) **Rising or falling Alarm:** This option allows the alarm to be set as a rising or falling type. If the alarm is rising then the reading must rise above the set-point for the alarm to be activated. If the alarm is falling then the reading must fall below the set-point for the alarm to activate.
- 23) **Contacts N/O or N/C:** This option allows the user to programme how the relay contacts are set on the rear panel. “Normally Open” means that the contacts are open circuit when an alarm is not activated and “Normally Closed” means that the contacts are closed when the alarm is not activated.
- 24) **Alarm Setpoints:** Use this box to programme the set-point value at which you want the alarm to activate. The units are in %, ppm, °C or mbar depending on which sensor you have assigned to the alarm.

Once you have finished editing the parameters, select ‘Write Configuration to Analyser’ from the file menu or click the ‘Write’ button on any configuration page and the new data set will be written to the Rapidox. The Rapidox is reprogrammed using the new configuration. The software then reads the new settings back from the Rapidox and displays them in the boxes on the left-hand side confirming that the configuration was successful.

8.6 On-Screen LCD

It is possible to display an LCD emulator on the desktop of your PC. This reproduces exactly the display on the Rapidox unit and is convenient if you are some distance away from the machine. To activate the LCD select the ‘Utilities’ menu and select the ‘Show LCD’ option. This will display a small window showing the LCD that can be positioned independently anywhere on the desktop.

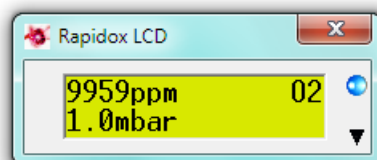

Figure 9: On-screen LCD

The blue LED indicator will flash to show that the display is updating. To close the LCD either click its window close button, or click the ‘Utilities’ menu on the main programme window and select the ‘Hide LCD’ option.

8.7 Remote Calibrating

With the on-screen LCD display active it is possible to remotely calibrate the analyser. Click on the down arrow icon in the bottom right-hand corner of the LCD display to expand the window:

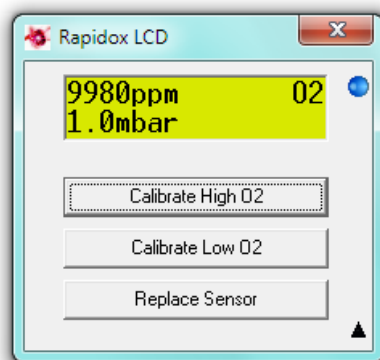

Figure 10: Remote calibration and replace sensor function

Use the two buttons to calibrate the sensor directly from the PC. Before calibrating make sure that you know the exact O₂ concentration in your gas bottle AND you have a calibration certificate from the gas supplier confirming the concentration. You can calibrate the analyser in any order but remember that the gas value for O₂ High must be greater than the gas value for O₂ Low. Allow sufficient time for the calibration gas to pass over the sensor and let the reading on the LCD stabilise. This is extremely important to perform a successful and accurate calibration; especially at low ppm values where it can take several hours for a stable reading.

The software uses the two calibration gas values already stored in the Rapidox as a starting point. These are typically High = 1%, and Low = 0.001% as set in the factory but may be different if the user has recalibrated with other gas values in the past. Either way you are given an option to change the cal gas value before proceeding to the actual calibration.

Assuming you are using 1% to calibrate O₂ High then simply click on the button labelled "Calibrate High O₂" to see the following:

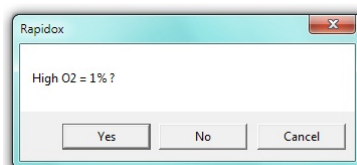

Figure 11: Calibration Gas Confirmation Screen.

If the current stored value is correct and matches your cal gas value then simply click "Yes" to proceed. If you are using a different value to the one you see on the screen then click "No" to change it as shown below:

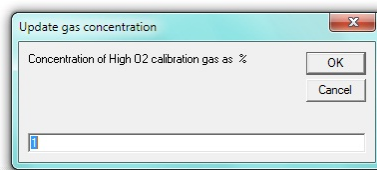

Figure 12: Calibration Gas Update Screen.

Enter your new value in the units as instructed and click “OK” to proceed. This value will then be stored until you want to change it again. You will now see the following screen:

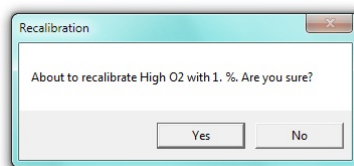

Figure 13: Calibration Confirmation Screen.

This is your final chance to change your mind before committing to a calibration. Check carefully that the gas value on the screen actually matches the value of your calibration gas before clicking on “Yes” to complete the calibration. At this point you should observe that the LCD display will reset itself to the correct calibration. You can now proceed with the rest of the calibration process by selecting the Middle and Low gases in the same manner.

8.8 Calibration Error Messages

During the calibration process described in 8.7 above it is possible to receive screen error messages as described here.

- 1) **Bad Sensor Reading:** The Rapidox software makes a prediction of the expected sensor mV for each calibration gas value entered. If the mV signal coming from the sensor is out of the expected range the following message is displayed:

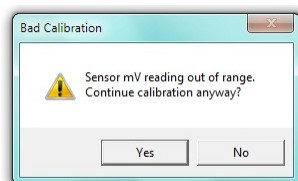

This normally indicates one of two things: that you are using the wrong cal gas value compared with the actual gas flowing over the sensor OR the sensor is getting old and can no longer output the expected signal required for a healthy calibration.

- 2) **Bad Pressure Reading:** The Rapidox software checks to see what the gas pressure is before allowing the calibration to continue. If the pressure is outside the range -25mbar to +25mbar (gauge) then the following message is displayed:

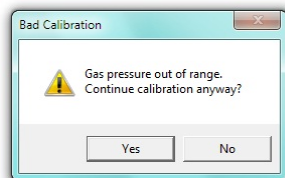

This normally indicates that you are allowing gas from a cylinder set at too high pressure to enter the analyser. Try displaying the pressure reading on the second line of the LCD and adjusting the gas regulator to trim it close to 0 mbar. If you are using a standard gas regulator then try switching off the sample pump on the rear of the analyser OR better still use a demand flow regulator and allow the gas to enter the analyser from the draw of the pump.

- 3) **Faulty Pressure Sensor:** If the pressure sensor is faulty or giving unexpected signals then if you attempt to calibrate the oxygen sensor whilst in AUTO pressure correction mode you will get a fault message and the Rapidox will refuse to continue with the calibration:

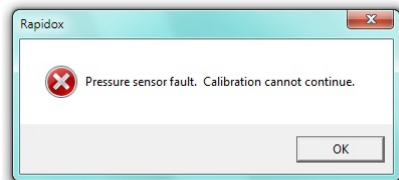

Please contact Cambridge Sensotec to advice. If you need to use the analyser in the meantime please disable the pressure correction function (see section 7.11) and you can continue to calibrate and take readings.

Note that 1) & 2) above are only advisories and you can proceed with the calibration if you believe everything is checked and correct.

8.9 Replacing the sensor

The sensor in R 1100LR has a life expectancy based on the amount of oxygen that it is exposed to, so sensor life is approximately 12-18 months on average. The Rapidox will warn you after one year of installation that the sensor is due for a change. Please see section 7.15 for a full description.

The method for replacing the sensor in the R 1100LR is described in a separate manual provided with the new sensor. Once the sensor has been replaced and the unit switched on please register the new sensor using the following procedure.

Referring to Figure 10 click on the button labelled “Replace Sensor”. The following message will appear:

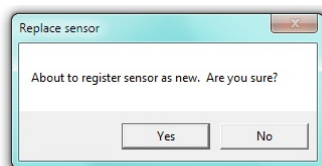

Figure 14: New Sensor Confirmation Screen

If you are replacing the sensor before the recommended due date the following screen will warn you about this:

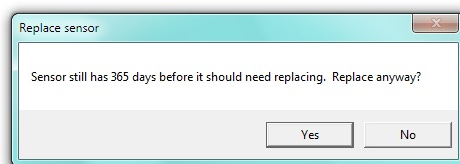

Figure 15: Premature sensor change check screen

Click yes to proceed and register the new sensor. This will reset the 365 day countdown clock.

8.10 Software Utilities

The utilities menu is located on the main file menu as shown below:

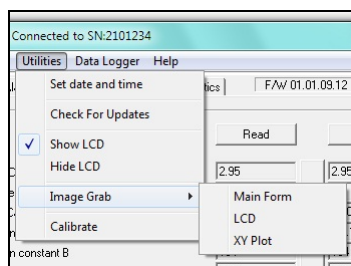

Figure 16: Software Utilities Menu

8.10.1 Setting Analyser Date and Time

The current date and time of your PC are displayed on the configuration screen and can be loaded into the Rapidox by selecting the Utilities menu and clicking the ‘Set date and time’ option. This information is used in the RS232 data string for data logging purposes. Make sure that your PC clock is set correctly before using this function, as you cannot edit the date and time shown by the Rapidox software. The date and time formats displayed are those set in the PC’s Regional Settings.

8.10.2 Check for Updates

This function will check online and advise you if any software updates are available for your machine. This function is not automatic. To update the software please visit www.cambridge-sensotec.co.uk and select the support page where a list of downloads are provided.

8.10.3 Image Grabber

This is a simple function to allow the user to copy the software screens into the Windows clipboard. This is useful for diagnosing problems; allowing a quick and simple way of sending the Sensotec technicians actual screen shots of the software. To recover the images simply press CTL+V to paste.

9. Rapidox Data-Logging Software

9.1 *Introduction*

The Rapidox software includes a full data logging facility. Data can be saved to a file automatically at regular intervals and the format is compatible with modern spreadsheet programmes such as MS-Excel. A live-time graphing facility is also included which has many powerful features. Note that the data logging facility will only function if the analyser is in NORMAL run mode, and will be suspended automatically during start up or if the set up menu has been activated via the front panel keypad.

9.2 *Setting up the Data Logger*

Click on the tab labelled 'Data Acquisition' to display the following page:

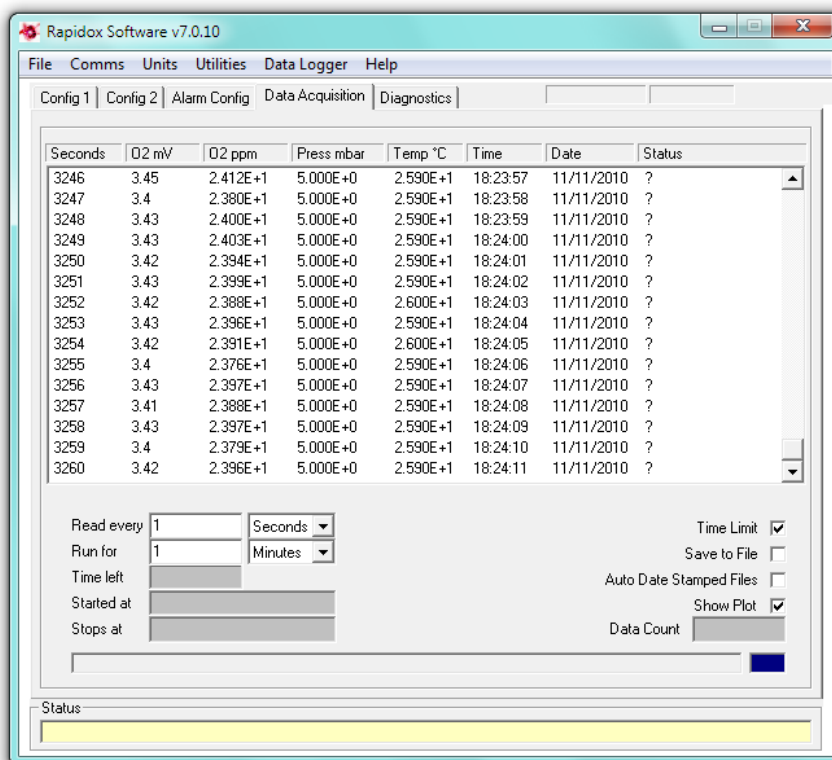

Figure 17: Data Logging page

During logging, data from the analyser is shown in the central area of this page. The data is displayed in the following columns: elapsed time (in seconds, minutes or hours), the raw signal from the sensor amplifier (in mV), the oxygen value (in ppm scientific notation), pressure in mbar, the temperature (in °C), the current time, the date (in regional format), and status (displaying the word 'ALMx' if any alarms are activated).

To start data logging select the frequency of measurement by entering a time and selecting a unit from the drop down list next to the 'Read every' label. For example if you wish to log data once every minute, type '1' in the box and select 'Mins' from the drop down menu.

You can open the NOTES window at any time by selecting 'Notes' from the 'Data Logger' drop down menu. A small text box appears in which you can type a text message. This note is then saved as a header in the data file set and can be viewed along with the data.

You can either choose to have data logged continuously until 'Stop' is selected from the Data Logger menu, or you can choose to set a time limit for data logging by checking the box labelled 'Time Limit', setting the duration in the 'Run For' box and selecting units with the drop down list. For example if you wish to log data for thirty minutes type '30' in the box and select 'Mins' from the drop down list.

9.3 *Running the Data Logger*

If you wish to save the data into a file for later use, check the 'Save to File' box before selecting 'Run' from the Data Logger menu. You will be prompted for a file name and location before data logging commences. The file and path information will appear in the box at the top of the page labelled 'Data File Name'. If you forget to select file saving before starting a run, you will nevertheless be prompted at the end as to whether you wish to save the acquired data.

The blue progress bar displays the state of completion of the run, and the blue box to the right of it the same information as a percentage. You can stop the run at any time by selecting 'Stop' from the Data Logger menu. The yellow 'Status' bar at the bottom of the page gives information about the data logging operation.

Once data logging is complete you may open the text format data file using any compatible spreadsheet programme such as MS Excel, and use the data to generate plots and reports.

You can pause the data logger at any time by selecting 'Data Logger' and 'Pause'. Click 'Data Logger' and 'Resume' to continue logging from where you left off, noting that the clock keeps ticking during the pause period.

9.4 *Auto Date Stamped Files*

If you are planning to run the data logger for extended periods of time then you should consider checking the 'Auto date stamped files' option. This feature will save the data at midnight for the previous twenty four hours and so on until the data-logging is complete OR the user interrupts. The data file is stored as a set of files, each with a date suffix in brackets in yyyy-mm-dd format.

This feature ensures that data is saved periodically in sensible sized files. This will prevent the computer from crashing and will also ensure that the data is small enough to fit into an Excel spreadsheet

As an example, the user wishes to run the data-logger for seven days recording every minute starting at lunchtime on 12th November 2005. He starts the data logger with the auto-date stamp function enabled. When prompted he gives the filename as 'test1'. In this situation the data logger will run from lunchtime to midnight and then save the first file as 'test1 (2005-11-12).txt'. The data logger then clears and continues for another twenty four hours until midnight the following day. The data is then stored as 'test1 (2005-11-13).txt'. This will continue for seven days when the data-logger will finish.

After this the user will have a sequence of files:

```
test1 (2005-11-12).txt  
test1 (2005-11-13).txt  
test1 (2005-11-14).txt
```

And so on. Combined together they represent all the data over the last seven days. Note that the Rapidox uses the computer clock and date to perform this action, so make sure that they are correct before starting a run.

To view the data in its entirety the user would, for example, need to load each file in turn back into Excel to combine them.

9.5 Live-time Graphing Screen

The Rapidox data-logging package includes a live-time graphing facility that allows you to monitor the progress of your data in a graphical format (see Figure 18). To access the graph check the box labelled 'Show Plot'. The graph will appear in a new window, and can be accessed at any time without disturbing a run that is already in progress. You can select 'Run', 'Pause' and 'Stop' from the 'Data Logger' menu on the 'Rapidox Plot' window to begin, pause and end data logging, and the window can be minimised to (and restored from) the task bar while logging data.

To close the window and return to the main data-logging page select 'Close Plot' from the 'File' menu or click on the close window button. You can also close the plot from the main window by un-checking 'Show Plot'. The features of the graph window are described below:

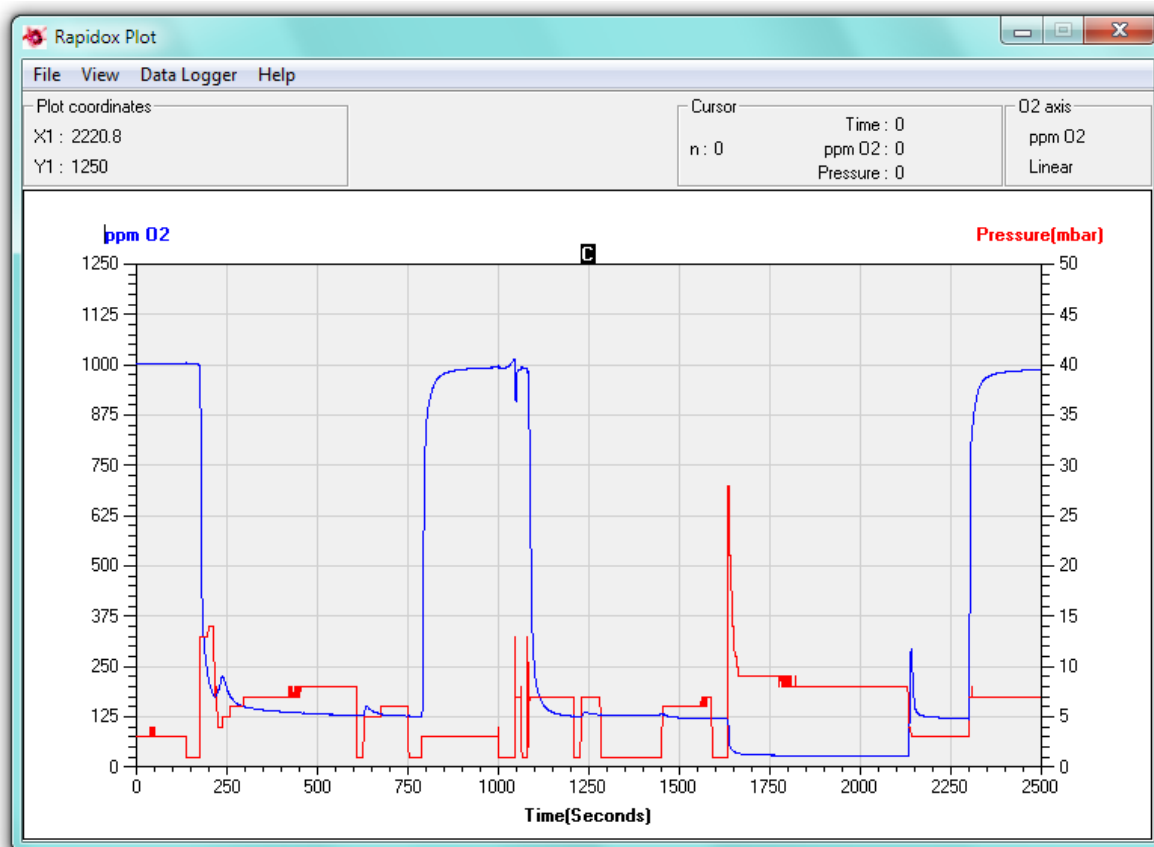

Figure 18: Live-time graphing screen

9.6 Main Graph Window

The graph is an XY plot, with time plotted on the X-axis, oxygen plotted on the primary Y-axis (Y1) and pressure or temperature plotted on the secondary Y-axis (Y2). The X-axis and the two Y-axes auto-scale during data logging so that all data points are shown on the graph. You can select what is shown on the Y2 axis using the 'View', 'Second axis display' menu.

9.7 Plot Colours

The default colours used on the graph are set to blue for oxygen and red for pressure or temperature. To change the colours double-click on the coloured axis label at the top of each axis. A colour palette window will appear and a new colour can either be chosen from a colour box, or for more variety, by clicking the 'Define Custom Colors >>' button. Click on 'OK' to select the new colour or 'Cancel' to return to the graph without change.

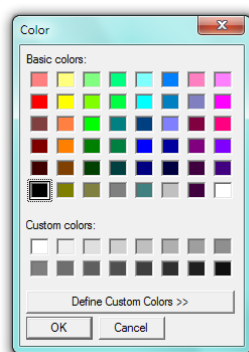

Figure 19: Plot colour palette menu

9.8 Graph Titles and Labels

If you want to change the text of the graph axis labels, place the mouse pointer over the text and do a single left click to enter edit mode. The text can then be modified. Similarly, to change the title of the graph, place the mouse pointer over the title and click once to edit. If you choose not to enter a title the graph will display the path and filename of the run as the new title once the run has finished. Note that these changes are only temporary and will be overwritten by the defaults if a new run is started or the graph window is closed and reopened. They are provided so that the plot may be printed with alternative labels.

9.9 Plot Co-ordinates

The box labelled 'Plot co-ordinates' to the upper left of the graph window displays the actual plot co-ordinate value at the mouse pointer. This can be used to get a quick oxygen value from the graph. Simply place the mouse pointer at a place of

interest and read the corresponding X1 and Y1 values in the box.

9.10 Last data point

During data acquisition, the box labelled 'Last data point' will appear at the upper middle of the graph window. It displays the most recent data values read from the analyser.

9.11 Using the Cursor

Clicking and holding the left mouse button with the pointer over the **C** at the top of the plot area activates the cursor, which appears as a vertical dashed line on the plot. While keeping the mouse button pressed, you can now move the pointer anywhere in the plot area or on the **C** in order to move the cursor. The box labelled 'Cursor' to the upper right of the graph window will display actual values for oxygen, temperature (or pressure), time and the data point number (n) at or immediately to the left of the cursor position. The cursor can be used to investigate actual data values at specific points of interest on the graph. The cursor is not available during data acquisition, but is available if the run is 'paused'.

9.12 Zooming

You can zoom in to any part of the oxygen plot by simply placing the mouse pointer on the new graph start position and then clicking and dragging a new box to re-size the graph. The label on the box to the upper left of the graph window will change to 'Zoom box co-ordinates', and an extra set of co-ordinates, labelled X2 and Y2, will appear, showing the co-ordinates in X and Y units of the second corner of the zoom rectangle as you drag the mouse pointer. The plot will zoom and auto-scale when you release the mouse button. This can be repeated if you wish to zoom in even further. To zoom back to the original size select 'Zoom Full' from the View menu. Note that although you can use the zoom facility during a live run, the graph will auto-scale to full size with each new data point.

9.13 Y-Axis Graph Units

You can toggle the Y1 oxygen units at any time from percent to ppm and vice versa. Select 'O2 Units' from the 'View' menu and choose either 'Percent' or 'ppm'. The current selection is then displayed in the top right box labelled 'O2 Axis'.

9.14 Oxygen Scale

You can display the Y1 oxygen axis in linear or logarithmic format at any time by selecting 'O2 Scale' from the view menu. The current selection is then displayed

in the top right box labelled 'O2 Axis'. Note that the zoom function is disabled when you are viewing on a log scale.

9.15 Second Y Axis

The secondary Y axis located on the right hand side of the graph can be used to display either the pressure taken from the internal pressure sensor or the gas temperature. The axis is linear and auto-scaling. To select the mode of the secondary axis select the 'View' menu followed by 'Second axis display'. Choose from 'None', 'Temperature' or 'Pressure'.

9.16 Loading an Old Run

A previously logged data file can be loaded and viewed by selecting 'Open Data File' from the 'File' menu and selecting the appropriate TXT or CSV file. A progress bar is displayed while the data is being imported. Note that very large data files may take several seconds to load. The data is re-graphed and you can zoom, label axes, change colours etc., before printing the graph.

9.17 Printing Graphs

You can print the graph at any time by selecting 'Print Plot' from the File menu. This will bring up the printer dialogue box for your specific printer where you can choose various printing options. Make sure that the printer page is set to landscape to obtain a full size print out.

9.18 Data Logging in the Background

It is possible to begin data logging and then minimise the windows to continue working with another application. To minimise the graph simply click on the minimise button on the blue title bar at the top of the window. You can then use the ALT + TAB keys to take you to other programmes already running. To return to the graph simply maximise from the start menu bar or press ALT + TAB again. If the graph does not redraw immediately select 'Zoom Full' from the View menu to redraw.

9.19 Pausing the Data Logging

You can pause the data-logging at any time during the run by selecting the 'Data Logger' menu and selecting 'Pause'. Repeat the action and click on 'Resume' to continue, noting that the live graph will draw a straight line between the paused points to keep continuity of the axes. The clock keeps ticking during the pause period.

If you decide to access the menu of the Rapidox using the front keypad during

data logging, then the software will pause automatically. A message appears on the screen informing the user that the unit is being accessed from the keypad. Once the menu has been exited, the software will continue data logging from where it left off.

9.20 *Changing the Data Logging Parameters Mid-run*

Once the data logging has begun you may change the sample interval time by pausing the data logger and then entering a new value for the time interval. The data logger can then be resumed with the new values in place. Note that you can not change units (e.g., seconds to hours) once logging has started. If you originally selected seconds then you may change the current value to a new value between 1 and 3600 seconds, if you originally selected minutes then you may change between 0.02 and 360 and if you selected hours you may change between 0.01 and 6 hours. Note it is not possible to modify the original total length of time that the data logging will run for once a run has commenced.

9.21 *Working with Spreadsheets*

The data-logger saves data files in a standard comma separated ASCII text format which can be readily imported into spreadsheet programmes such as MS Excel, in order to produce plots and reports as desired. For specific information on how to import text files into your spreadsheet programme please refer to the help guide supplied with the programme.

Data is saved in comma separated value format, with a '.txt' file extension as the initial programme default. However, when entering the file name, you can instead select a '.csv' extension: the programme will register the last used file extension as the new default. The '.csv' extension is recognised by MS Excel, so that opening the file will automatically run MS Excel, and this may be of benefit if your regional decimal separator is period '.' rather than comma ','. However, if your decimal separator is comma, you should continue to use the '.txt' extension and open the file explicitly from within your spreadsheet programme, defining the field delimiter as 'comma' where appropriate.

9.22 *Disaster Recovery*

To prevent catastrophic loss of important data during a computer crash or power failure, the data is automatically saved point by point in a temporary file called 'Rapidox temporary data file XXXXXXX.txt' (where 'XXXXXXX' is the serial number). This file is located in the same directory as the main Rapidox programme itself and can be renamed or copied to recover data that would otherwise be lost. Note that this file is overwritten each time 'Run' is selected from the 'Data Logger' menu so make sure all data is recovered successfully before starting another run.

Note that during a run using the 'auto date stamped' feature, the temporary data

file is wiped clean as soon as the previous data set has been saved successfully. In the case of a crash the temporary data file should be used to recover the last day's worth of data that was not saved to the hard disc.

9.23 Diagnostics

The Rapidox software includes a diagnostics page that is accessed from the tab labelled 'Diagnostics'. This screen will display various values and settings that are operating inside your machine. There is no editing possible on this page – it is purely for information and to enable technical support help you should you experience difficulties with your machine. You may be asked to record values from this page if trouble shooting is required.

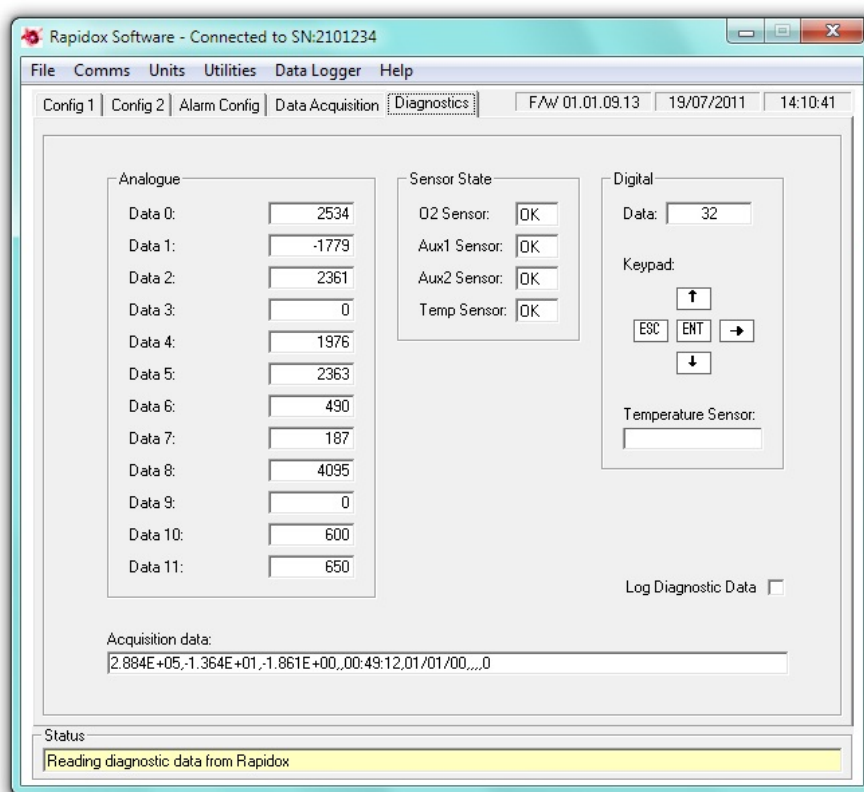

Figure 20: Rapidox Diagnostics Page

- 1. Analogue:** The live analogue values displayed in this pane are voltage measurements coming directly from the computer chip inside the analyser. They are for information purposes only but are a useful diagnostics tool for Sensotec staff, as unusual values can indicate a particular fault. To help Sensotec diagnose a fault please capture this window as shown above using the screen capture function described in section 8.10 above and e-mail it to support@cambridge-sensotec.co.uk
- 2. Sensor State:** These boxes should all indicate “OK” on a healthy analyser. The possible messages are “OK” “High” “Low” or “Fault”. The High and

Low messages indicate that the sensor is out of normal range. The fault message will only display if the sensor is disconnected or has failed in some way.

3. **Digital:** The digital signals coming directly from the computer chip inside the analyser can be monitored here. To test the keypad is working correctly try pushing the buttons and watching the panel. A correctly functioning key will turn the box red on the screen and the digital value for that particular key will show in the data box. If the analyser has an external thermocouple correctly fitted (2100 and 3100 series only) then this will display a signal in the “Temperature Sensor” box.
4. **Log Diagnostic Data:** Checking this box will allow the software to log the diagnostic data which can then be e-mailed to Sensotec for analysis. Do not switch to a different tab while logging diagnostic data – the data is only logged while the “Diagnostics” tab is still selected. The software will log diagnostic to a file named “Rapidox diagnostics file 210xxxx.txt” (where “xxxx” is the serial number of the analyser) in the folder shown in the yellow “Status” box at the bottom of the screen. Data is logged every 6 seconds, so the software should be left to run for at least 1 minute to gather a few data points. In order to stop logging, simply uncheck the “Log Diagnostic Data” tick box. Note that diagnostic data is always saved to the same file, and will automatically overwrite any existing file without prompting the user, so if you want to save existing data you must either rename it or copy (or move) it to a different folder, before checking the “Log Diagnostic Data” tick box again. If you are logging diagnostic data during the analyser’s warm up period, the “Acquisition data:” box will display the current sensor heating message, and will only display acquisition data once the oxygen sensor has reached its operating temperature.

Once completed please e-mail this file to support@cambridge-sensotec.co.uk for analysis.

10. Troubleshooting

Q: The Rapidox says 'O/Range' and won't begin measuring.

A: The sensor is not designed to measure oxygen above 10,000ppm so if the machine has been switched off for a long time or the tubing has been exposed to oxygen rich gas then please wait a while for the low oxygen gas to flush through. After several minutes the message should clear and the unit will start to take measurements.

Q: The Rapidox won't power up at all.

A: There are fuses located on the power socket on both live and neutral lines. These are standard 20mm 2A slow blow fuses available from a supplier such as RS Components.

Q: The Rapidox gives strange readings that are way off the expected values.

Cambridge Sensotec Rapidox 1100LR Oxygen Analyser Instruction Manual

- A: Check to make sure which calibration gases are selected. Are they the same as the actual gases you used to perform the calibration? If not you must recalibrate the analyser or re-load the factory defaults to get you going again. Also check to see that the pressure correction mode is set to AUTO and that the ambient pressure is set correctly.
- Q: I messed up the calibration procedure and the analyser is not working properly.
- A: Return the unit to the factory defaults using the keypad or communications software, by selecting 'Default Configuration' followed by 'Write Configuration to Analyser' from the File menu. Now try re-calibrating the Rapidox.
- Q: The software will not talk to the Rapidox.
- A: Make sure that you are using the correct cable, as supplied (pin 2 to pin 2 etc). A crossed RS232 cable (pin 2 to pin 3 etc.,) will not work. Make sure that your COM ports are recognised by your computer. Check in your Windows device manager to see if there are any conflicts. If you have an internal modem fixed to your PC you may experience difficulties using this software. Contact Cambridge Sensotec for further advice.
- Q: I selected 'Write to the Analyser' and now the Rapidox is way off calibration.
- A: Only select 'Write to the Analyser' once all the values are correctly entered in the boxes on the right. The best procedure is to 'Read Analyser Configuration' and then press 'Copy' so the values in the boxes are the same as those stored in the Rapidox memory. You can then edit these values and then select 'Write to the Analyser' when finished.
- Q: How do I get back to the factory calibration for my instrument.
- A: Select 'Default Configuration' from the 'File' menu and load the default 'rxc' file from the Rapidox software programme folder on your PC, or look for the default 'rxc' file on your CD. Select this file and then select 'Write to the Analyser'. This will load the factory calibration back into the Rapidox. Alternatively you can load a standard default configuration any time using the '11-Load Defaults' option from the user menu which is accessed via the front panel keypad. This configuration will not be perfect for your analyser but will be good enough to get you started again.

11. Warranty

The Rapidox analyser has been carefully tested and inspected before shipment and is guaranteed to be free from defective materials and workmanship for a period of twelve months from date of purchase. The sensor head is replaceable and has a life expectancy of one year approximately. However, if the analysis gas contains corrosive gases or large quantities of particulates, sensor life may be shortened. In the case of the latter, it is normally possible to insert a filter prior to the sensor head to remove the particulate material.

11.1 Conditions of Warranty:

- 1) This warranty is in addition to and does not affect any statutory rights of consumer purchasers. This warranty is valid worldwide on a “back to base basis”.
- 2) This warranty covers breakdowns due to design or manufacturing faults; it does not apply to damage, however caused, wear and tear, neglect, unauthorised adjustment or repair, or any items of limited natural life.
- 3) In the event of failure, please take the following action:
 - a) Refer to the “Troubleshooting” section of your instruction manual to identify and possibly correct the problem.
 - b) If the fault cannot be resolved, please contact the Cambridge Sensotec service and repair centre at the address given on the cover of the manual.
- 4) The warranty period applicable shall be 12 months from the date of delivery provided that:
 - a) Notice in writing of the defects complained of shall be given to Cambridge Sensotec (The Seller) upon their appearance, and
 - b) such defects shall be found to have arisen from the Seller's faulty design, workmanship or materials, and
 - c) The defective goods shall be returned to the Seller's premises at the Purchaser's expense if so requested by the Seller.
 - d) Any repaired or replaced goods shall be redelivered by the Seller free of charge to the original point of delivery but otherwise in accordance with and subject to these Conditions of Sale.
 - e) Alternatively the Seller shall be entitled at its absolute discretion to refund the price of the defective goods in the event that such price shall already have been paid by the Purchaser to the Seller, or, if such price has not been so paid, to relieve the Purchaser of all obligation to pay the same by the issue of a credit note in favour of the Purchaser in the amount of such price.



Rapidox CERTIFICATE of CALIBRATION

Date:

Rapidox Serial number:

Calibration Constant A

Calibration Constant B

Calibration Gas 1

Calibration Gas 2

Configuration Filename

Calibrated by:

Signed:

Cambridge Sensotec Limited
Unit 29 Stephenson Road
St Ives
CAMBS
PE27 3WJ



Tel. +44 1480 462142
Fax. +44 1480 466032
www.cambridge-sensotec.co.uk
sales@cambridge-sensotec.co.uk
VAT no. GB 745 939975
Registered in England No. 4035592

Cambridge Sensotec Rapidox 1100LR Oxygen Analyser Instruction Manual

APPENDIX 1: MENU FLOWCHART FOR RAPIDOX 1100L

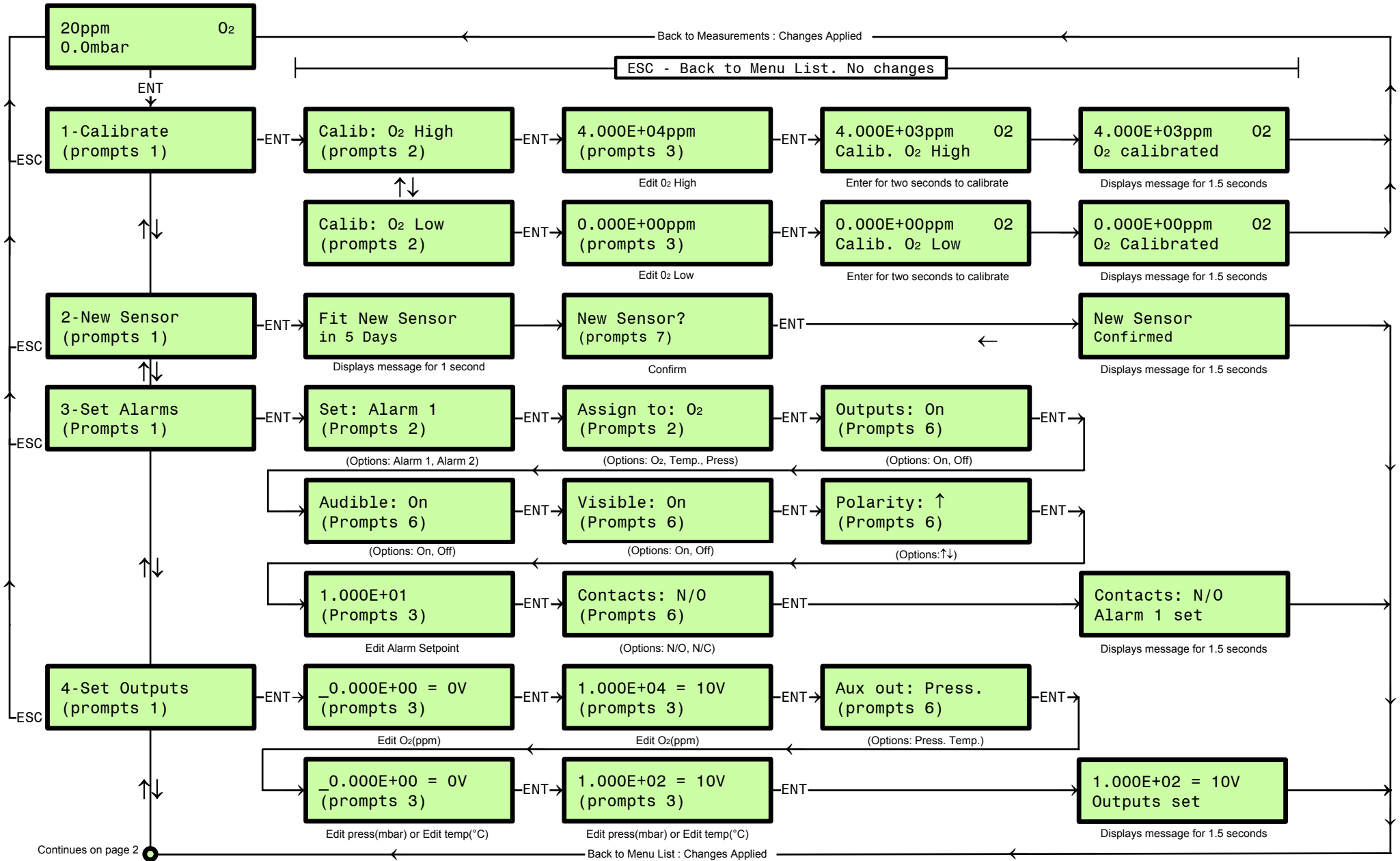

Continues on page 2

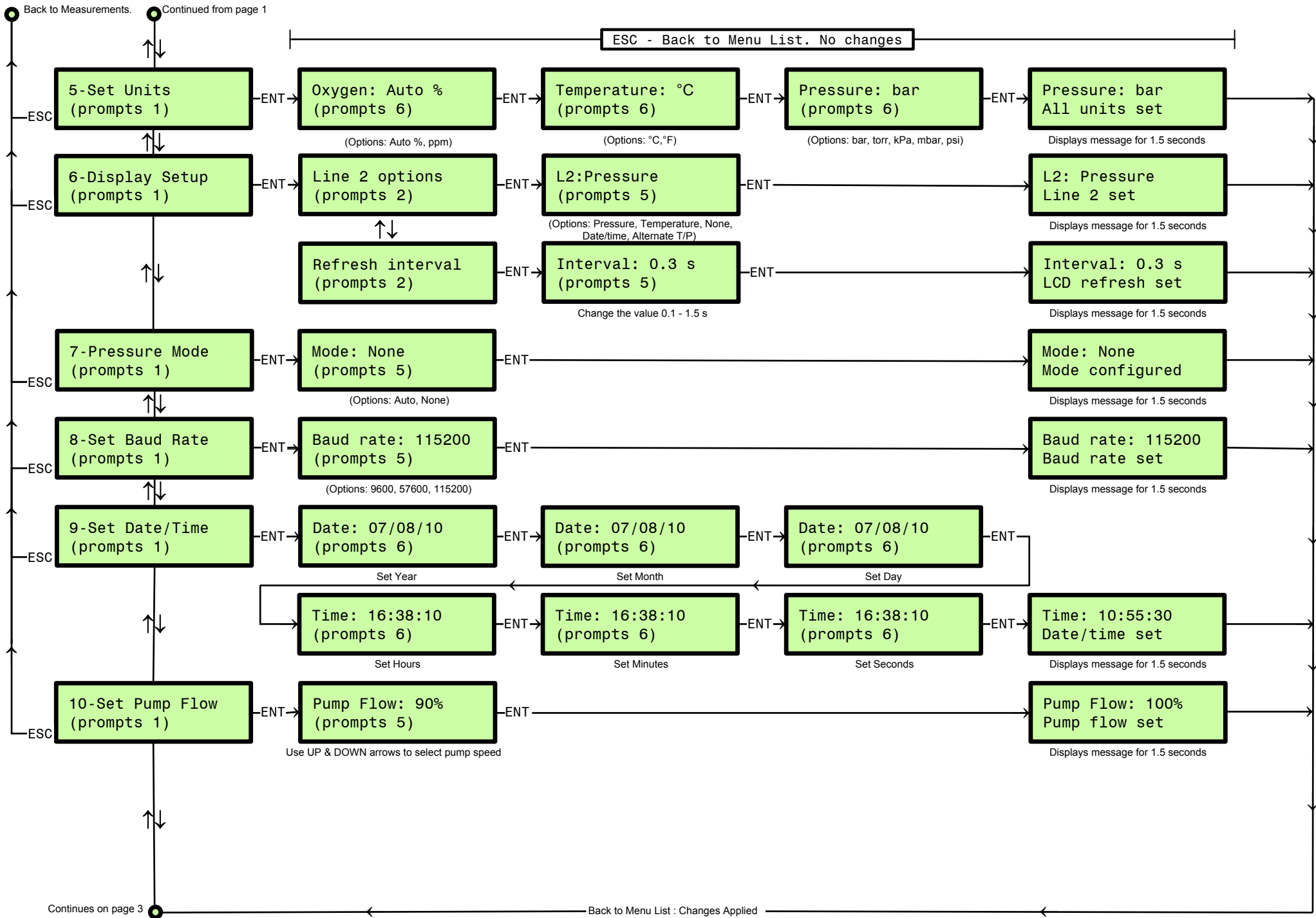

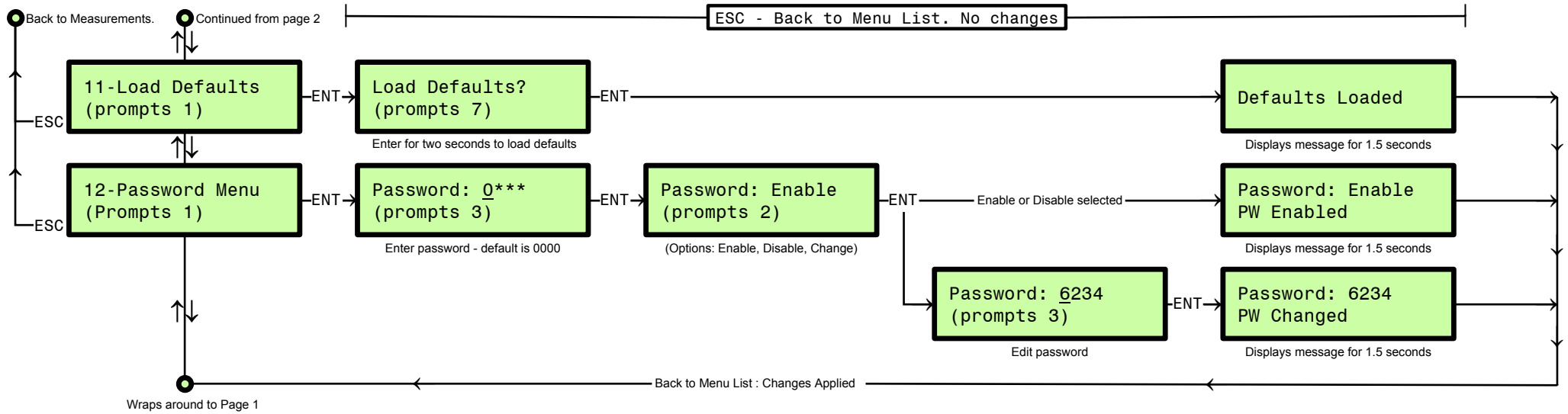

Prompts 1:	Prompts 2:	Prompts 3:	Prompts 4:	Prompts 5:	Prompts 6:	Prompts 7:
↑↓ = Scroll Menu ENT = Next ESC = Exit	↑↓ = Scroll Menu ENT = Next ESC = Back	↑↓ = Change → = Select Char. ENT = OK ESC = Back	ENT = OK ESC = Back	↑↓ = Change ENT = OK ESC = Back	↑↓ = Change ENT = Next ESC = Back	ENT for 2s = OK ESC = Back