

**STATUS SCIENTIFIC CONTROLS**

Issue: 1

Date: 6.10.2008.

Firmware: V1.0.4



# **Installation, Commissioning & Routine Gas Testing Manual**

## **Gas Detector Type FGD10B Pellistor**



# STATUS SCIENTIFIC CONTROLS

## Status Scientific Controls Ltd

Hermitage Lane Industrial Estate,  
Kings Mill Way, Mansfield,  
Nottinghamshire, England.  
NG18 5ER

[www.status-scientific.com](http://www.status-scientific.com)



ISO 9001:2000

Certificate No. GB93/1938

## Manufacturer's EC Declaration of Conformity

We declare, under our sole responsibility, that we believe the products identified in this declaration, and to which this declaration relates are in conformity with the requirements of the following Council Directives:

- 89/336/EEC as amended by 92/31/EEC on the approximation of the laws of the Member States relating to Electromagnetic Compatibility.
- 94/9/EC on the approximation of the laws of the Member States concerning equipment and protective systems intended for use in potentially explosive atmospheres.

### Description of Equipment:

The FGD10 Series of Fixed Gas Detectors for the detection of Oxygen, Toxic or Flammable gases.  
ATEX Flameproof Certified for use in Group IIC hazardous locations.

### Standards applied:

Electrical apparatus for explosive gas atmospheres -General requirements.	EN60079-0:2006
Electrical apparatus for explosive gas atmospheres -Flameproof enclosure 'd'.	EN60079-1:2007
Electromagnetic compatibility - Electrical apparatus for the detection and measurement of combustible gases, toxic gases or oxygen.	EN50270:2006
Electromagnetic compatibility. Generic emission standard. Industrial environment.	EN61000-6-4:2007
Electromagnetic compatibility. Generic standards. Immunity standard for industrial environments.	EN61000-6-2:2005

### Notified Body for Hazardous Area Certification:

SIRA Certification Service  
Rake Lane, Eccleston,  
Chester, CH4 9JN.  
Notified Body Number : 0518

### Notified Body for ATEX Quality Assurance Notification:

Baseefa  
Rockhead Business Park  
Staden Lane, Buxton SK17 9RZ, UK  
Notified Body Number : 1180

### Product Hazardous Area Certificate Number:

SIRA 08ATEX1031X

### ATEX Quality Assurance Notification Number:

2056

### Place of Manufacture:

Mansfield, Nottinghamshire, UK. Date mark applied – see product

### ISO 9001:2000 Quality Management System:

Certificate No. GB93/1938

Authorised Signatory to this declaration, on behalf of the manufacturer:

Name: W. R. Baxter Title: Managing Director

Address: Status Scientific Controls Ltd, Hermitage Lane Industrial Estate, Kings Mill Way  
Mansfield, Nottinghamshire, NG18 5ER, United Kingdom

Signature

Date: 27.3.08.

Tel : +44 (0)1623 651381

Fax : +44 (0)1623 421063

e-mail : [sales@status-scientific.com](mailto:sales@status-scientific.com)

# STATUS SCIENTIFIC CONTROLS

Installation, Commissioning & Routine Gas Testing  
FGD10B Pellistor Gas Detector



## CONTENTS

<b>1.</b>	<b>PACKAGE CONTENTS .....</b>	<b>5</b>
<b>2.</b>	<b>SCOPE OF THE MANUAL .....</b>	<b>5</b>
<b>3.</b>	<b>DESCRIPTION .....</b>	<b>6</b>
3.1.	GAS TYPES .....	7
<b>4.</b>	<b>INSTALLATION .....</b>	<b>8</b>
4.1.	CABLE ENTRIES .....	9
4.2.	MOUNTING AND TERMINAL ACCESS .....	9
4.3.	FGD10B CONNECTIONS .....	10
4.4.	WIRING DETAILS .....	11
4.4.1.	FGD10B Infrared current sink .....	11
4.4.2.	FGD10B Infrared current source .....	11
<b>5.</b>	<b>COMMISSIONING .....</b>	<b>12</b>
5.1.	APPLYING POWER .....	12
<b>6.</b>	<b>INITIAL GAS TESTING .....</b>	<b>13</b>
6.1.	ZERO GAS .....	13
6.2.	TEST GAS .....	15
6.2.1.	Gas connection points .....	15
6.2.2.	Sampling time .....	16
6.2.3.	Suggested calibration gas levels. ....	16
<b>7.</b>	<b>CALIBRATION .....</b>	<b>17</b>
7.1.	SENSOR ZERO .....	17
7.2.	SENSOR SPAN .....	18
7.3.	CALIBRATION / CONFIGURATION KEYPAD .....	19
7.4.	MENU MODE SELECTION .....	21
7.4.1.	E : 1 – Sensor Zero .....	22
7.4.2.	E : 2 – Sensor Span .....	22
7.4.3.	E : 3 – Sensor Fsd .....	22
7.4.4.	E : 4 – Output Zero (4mA) .....	22
7.4.5.	E : 5 – Output Span (20mA) .....	22
7.4.6.	E : 8 – Sensor Type .....	23
7.4.7.	E : 9 – Engineer diagnostics .....	24
7.4.8.	E : 17 – Sensor gain .....	25
7.4.9.	E : 19 – Positive Zero Suppression .....	26
7.4.10.	E : 20 – Negative Zero Suppression .....	26
7.4.11.	E : 25 – Positive Zero Temperature Compensation .....	27
7.4.12.	E : 34 – Positive Span Temperature Compensation .....	27
7.4.13.	E : 35 – Negative Span Temperature Compensation .....	27
7.4.14.	E : 36 – Positive Zero Temperature Compensation .....	27
7.4.15.	E : 77 – Firmware Version .....	27

# STATUS SCIENTIFIC CONTROLS

Installation, Commissioning & Routine Gas Testing  
FGD10B Pellistor Gas Detector



<b>8.</b>	<b>CALIBRATION</b> .....	<b>28</b>
8.1.	SENSOR CALIBRATION .....	28
8.1.1.	<i>Sensor Zero</i> .....	28
8.1.2.	<i>Sensor Span</i> .....	29
8.2.	ANALOGUE OUTPUT CALIBRATION .....	30
8.2.1.	<i>Analogue Output Zero</i> .....	31
8.2.2.	<i>Analogue Output Span</i> .....	31
<b>9.</b>	<b>ROUTINE GAS TESTING</b> .....	<b>32</b>
<b>10.</b>	<b>SENSOR REPLACEMENT</b> .....	<b>33</b>
10.1.	OXYGEN / TOXIC SENSOR .....	33
<b>11.</b>	<b>FUSES</b> .....	<b>38</b>
<b>12.</b>	<b>SPECIFICATION</b> .....	<b>38</b>
<b>13.</b>	<b>DIMENSIONS</b> .....	<b>39</b>
<b>14.</b>	<b>CERTIFICATION</b> .....	<b>40</b>

# STATUS SCIENTIFIC CONTROLS

Installation, Commissioning & Routine Gas Testing  
FGD10B Pellistor Gas Detector



## 1. PACKAGE CONTENTS

The FGD10B is supplied in a box containing the following items:-

<b>Description</b>	<b>Stock No</b>
FGD10B Gas Detector	*
Installation manual	**
Calibration certificate	

Optional:-

Weather guard	SS749
Calibration / Configuration Keypad	SS748

\* Refer to [www.status-scientific.com](http://www.status-scientific.com) for Stock No's for various gas types.

\*\* The manual may be supplied on a CD

## 2. SCOPE OF THE MANUAL

This manual relates specifically to the version of the FGD10B gas detector fitted with one of the following sensor types:-

- A Pellistor sensor.

# STATUS SCIENTIFIC CONTROLS

Installation, Commissioning & Routine Gas Testing  
FGD10B Pellistor Gas Detector



## 3. DESCRIPTION

The FGD10B is an explosion protected ATEX and IECEx certified fixed gas detector for use in potentially explosive atmospheres.



The unit may be optionally fitted with a protective weather guard as shown in the following photograph.



**IMPORTANT – When used in hostile environments (e.g. oil platforms where the instrument is exposed to salt spray or diesel) it is recommended that the FGD10B is always fitted with its protective weather guard. The weather guard is attached with tamperproof screws to ensure that it is not inadvertently removed.**

# STATUS SCIENTIFIC CONTROLS

Installation, Commissioning & Routine Gas Testing

FGD10B Pellistor Gas Detector



The unit comprises an instrument housing having two cable gland entries, one of which is normally fitted with a certified blank, and containing the connection terminals and electronics.

The housing containing the gas sensor has an M27 thread and is screwed into the bottom of the unit. The sensor housing itself is a certified component and must not be removed in service.

The main electrical features of the unit are:-

- Power supply – 8 to 24 volts dc (non-intrinsically safe)
- Loop powered 4 to 20mA dc
- Gland entry threads available – 20mm, ½” or ¾” NPT

## 3.1. Gas types

Versions of the FGD10B Oxygen Toxic are available for detection of gases, fitted with any of the following sensor types:-

- Flammable

# STATUS SCIENTIFIC CONTROLS

Installation, Commissioning & Routine Gas Testing  
FGD10B Pellistor Gas Detector



## 4. INSTALLATION

It is important that the correct cable and gland types are used when installing the FGD10B in a hazardous location.

The cable entry devices and blanking elements of unused apertures shall be of a certified flameproof type, suitable for the conditions of use and correctly installed.

With the use of conduit, a suitable certified sealing device such as a stopping box with compound shall be provided immediately at the entrance to the flameproof enclosure.

In order to prevent dangerous overloading of the FGD10B gas detector, it is fitted with an internal self resetting fuse which limits the maximum allowable power dissipation.

Guidance on the correct installation of systems is provided by EN60079-14:2003. It is the responsibility of the installer to ensure compliance with the relevant standards.

To ensure effective gas detection, the FGD10B must be located at a height appropriate to the density of the target gas relative to air. For example, Methane (relative density 0.55) is lighter than air and so it will tend to accumulate at a high level within a confined space. Whereas Petroleum (relative density 2.8) is heavier than air and it will tend to accumulate at around ground level.

European standard EN 61779-1:2000 provides comprehensive flammability data (including relative density) on approximately 300 types of gases.



# STATUS SCIENTIFIC CONTROLS

Installation, Commissioning & Routine Gas Testing  
FGD10B Pellistor Gas Detector



## 4.3. FGD10B connections

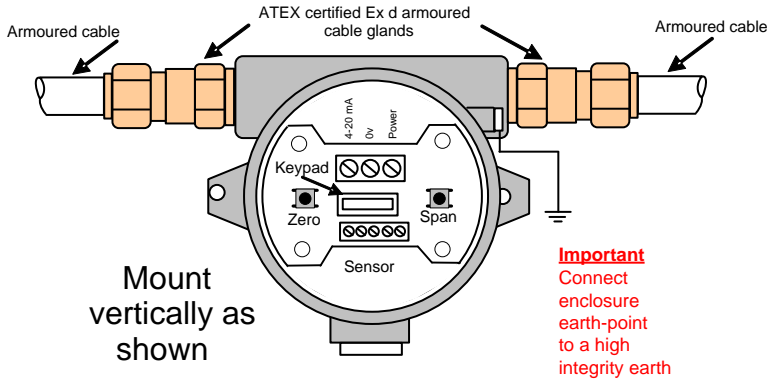

Figure 2 – Armoured Cable Gland Installation

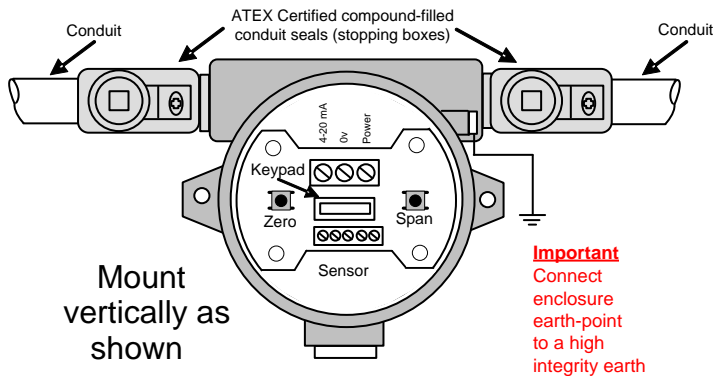

Figure 3 – EEx d Conduit Installation

# STATUS SCIENTIFIC CONTROLS

Installation, Commissioning & Routine Gas Testing  
FGD10B Pellistor Gas Detector



## 4.4. Wiring details

The infrared gas detector is a 4 to 20 mA loop powered device that operates from a supply of 8 – 24 volt dc supply and as such only requires two wires.

### 4.4.1. FGD10B Pellistor current sink

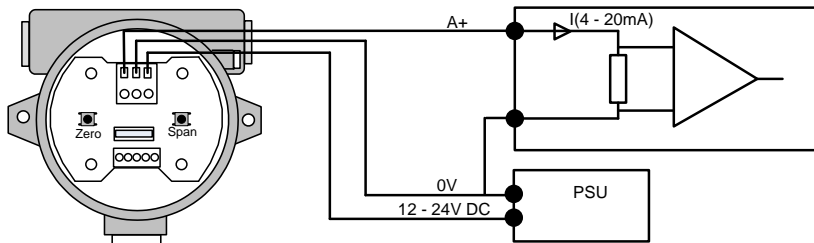

Note - The amplifier and power supply may be contained on the same control card.

Fig 4b

### 4.4.2. FGD10B Pellistor current source

# STATUS SCIENTIFIC CONTROLS

Installation, Commissioning & Routine Gas Testing  
FGD10B Pellistor Gas Detector



## 5. COMMISSIONING

Following completion of the installation:-

Ensure that the front cover has not been contaminated with dirt - paying particular attention to the thread. Replace the cover by rotating it several times clockwise until it reaches its limit then secure using the locking screw, turning in an anti-clockwise direction – do not over tighten.

### 5.1. Applying power

Once the installation is complete and the covers are secure then power can be applied. The power source should be between 12 and 24 volts dc.

## 6. INITIAL GAS TESTING

FGD10B units are factory calibrated as detailed on the calibration certificate supplied with the instrument. However, it is always advisable after installation to confirm that the instrument reads zero with no gas present and responds accurately when presented with an appropriate concentration of the target gas.

The FGD10B sensor should be allowed to stabilise for the period specified on the associated calibration certificate before attempting to check the zero setting and gas response.

### 6.1. Zero gas

With no gas present check that the associated control panel display reads zero.

- a) If the instrument reads zero then no adjustment is required and gas response testing may now be carried out as described in Section 6.2.
- b) If the instrument does not read zero then adjustment of the zero setting is required as described in Section 8.1.1. - Sensor Zero.
- c) If the analogue signal is connected to an associated control panel, confirm that when the FGD10B display reads zero, the control panel display also reads zero or, adjust as necessary in accordance with the control panel manufacturers' instructions.

*\* Note – If there is the possibility of a background gas being present then zeroing of the detector should be carried out using a test gas cylinder of air in nitrogen.*

# STATUS SCIENTIFIC CONTROLS

Installation, Commissioning & Routine Gas Testing  
FGD10B Pellistor Gas Detector



Figure 7 – Arrangement for Application of a Certified Test Gas

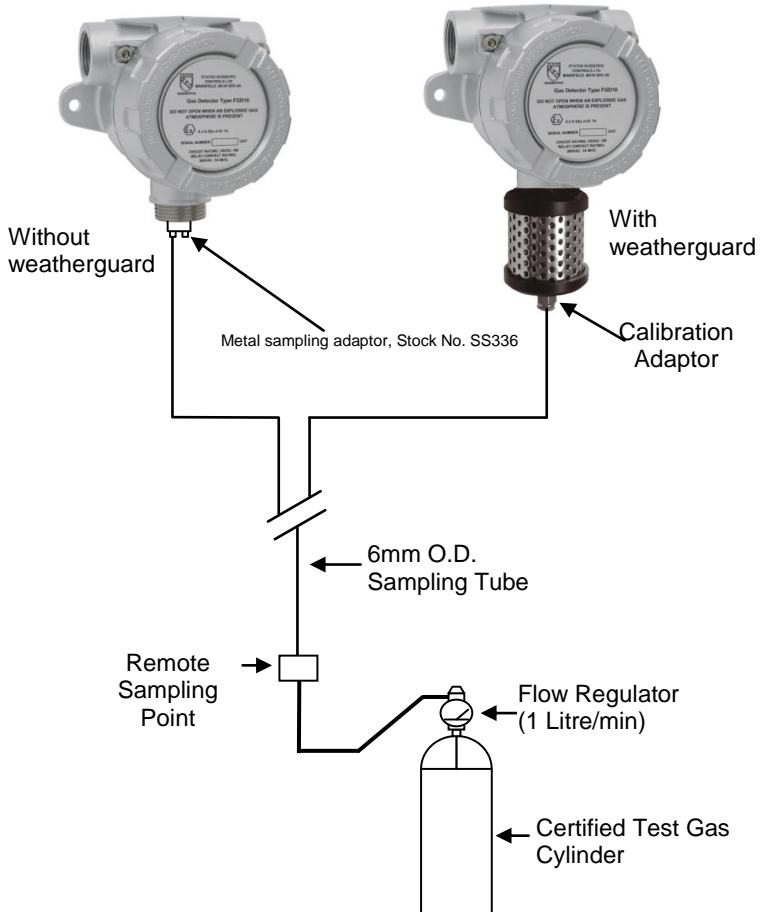

## 6.2. Test gas

Figure 7 shows a typical arrangement for the application of a certified test gas.

The purpose of the test gas response check is to confirm that that the reading on the instrument corresponds with the test gas concentration.

- a) If the associated control panel reads correctly then no adjustment is required.
- b) If the above checks are satisfactory then the installation is now complete.
- c) If the instrument does not read correctly then adjustment of the sensor span setting is required as described in Section 8.1.2. - Sensor Span.

### 6.2.1. Gas connection points

Certified test gas can be applied either:-

- a). directly to the FGD10B via the appropriate sampling/calibration adaptor.

or

- b). remotely, by connecting a test gas sampling tube to the appropriate sampling/calibration adaptor and installing a test point at the remote end of the tube.

Method b) avoids the need to gain direct access to the unit in order to carry out routine gas testing. The sample tube should be taken to a convenient point and sited such that the risk of contamination is minimised. A means must be provided to 'cap off' the tube when not in use in order to prevent blockage.

The weather guard is provided with a 6mm O.D. push in tube connector to allow connection of a gas sampling tube. Firstly, remove the blanking plug by depressing the coloured plastic ring whilst pulling on the plug; now push in the gas sampling tube. The standard fitting is a push fit connector for 6mm O.D tubing. The connector is screwed into a 1/8" BSP thread; other fittings are available on request.

Where a weather guard is not fitted, the use of a sampling adaptor (Stock No. SS336) is required in order to present the gas to the FGD10B sensor.

# STATUS SCIENTIFIC CONTROLS

Installation, Commissioning & Routine Gas Testing  
FGD10B Pellistor Gas Detector



## 6.2.2. Sampling time

Apply the test gas and allow a sufficient time for the sample to reach the gas detector. The response time will vary according to the length of the sampling tube.

## 6.2.3. Suggested calibration gas levels.

### Pellistor sensor:

Zero 20.9 %v/v oxygen balance nitrogen.

Span 50 % of measuring range (FSD) balance air.

# STATUS SCIENTIFIC CONTROLS

Installation, Commissioning & Routine Gas Testing  
FGD10B Pellistor Gas Detector



## 7. CALIBRATION

Calibration of the sensor can be carried out by using the buttons on the circuit board as seen in Fig1 and Fig 2.

These buttons only work when the FGD10B has been powered for a minimum of 10 minutes.

### 7.1. Sensor Zero

Fig 1

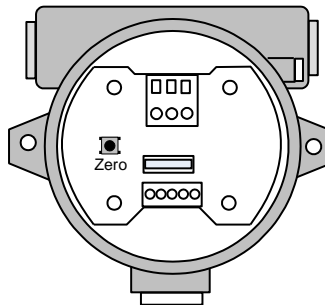

Ensure the sensor is in a zero-gas environment.

**Note:** Where a purging gas has to be applied, use a flow rate of between 500 and 1000 cc/min. Allow sufficient time for the sensor to respond.

Press the Zero button  zero and hold for a minimum of 5 seconds to zero the sensor.

# STATUS SCIENTIFIC CONTROLS

Installation, Commissioning & Routine Gas Testing  
FGD10B Pellistor Gas Detector



## 7.2. Sensor Span

Always zero the sensor prior to performing a span operation.

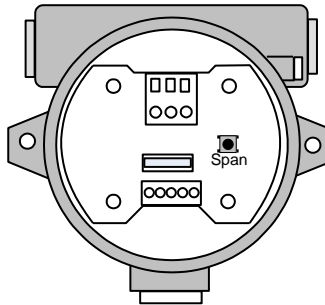



Fig 2

Apply a known concentration of gas (applicable to sensor type) at a flow rate of between 500 and 1000 cc/min. Allow time for the sensor to respond.

Press the Span button  and hold for a minimum of 5 seconds to span the sensor.

Turn off and disconnect the calibration gas.

**Note:** The calibration gas level must match with the level stored in the instrument. If the gas level is does not match then the keypad must be used to set the correct gas level.

# STATUS SCIENTIFIC CONTROLS

Installation, Commissioning & Routine Gas Testing  
FGD10B Pellistor Gas Detector



## 7.3. Calibration / Configuration Keypad

The FGD10B sensor can be calibrated via a purpose designed keypad. The keypad allows the user to carry out the following:

- 1) Calibrate the sensor.
- 2) Calibrate the 4 to 20 mA loop.
- 3) View the current gas level.
- 4) View the sensor raw data for diagnostic purposes.

Connect the keypad into the FGD10B as shown below:



The display will give the following messages:

SSCL	Company
----	
88:88	Segment test
SSCL	Manufacturer
1.0.3	Firmware version
----	
0.0	Gas reading

**Note:** if the display is continually showing - - - - then the instrument is not communicating with the keypad.

# STATUS SCIENTIFIC CONTROLS

Installation, Commissioning & Routine Gas Testing  
FGD10B Pellistor Gas Detector



The menu system featured within the keypad calibration unit allows all calibration and configuration activities to be performed.

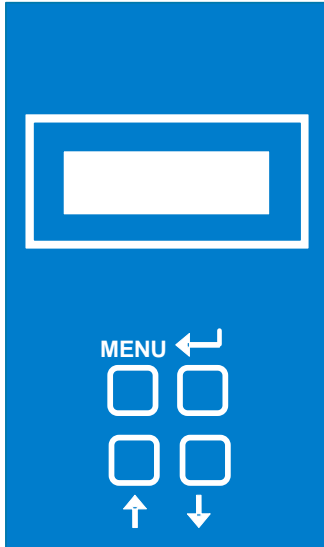

The keypad has the following functionality:

	Button	Function	Alternate Function
MENU	MENU	Open / Close Menu	Password
↑	UP	Next / Increase	1
↓	DOWN	Previous / Decrease	2
↵	ENTER	Accept selection	3

This section of the manual discusses how the available menu options can be accessed, how the associated parameter may be changed via the selected menu option and what effect the change to the parameter has on the operation of the FGD10B Infrared gas detector.

**Note:** It is important that the FGD10B is correctly configured for the sensor in use, prior to performing any feature available in the menu system.

# STATUS SCIENTIFIC CONTROLS

Installation, Commissioning & Routine Gas Testing  
FGD10B Pellistor Gas Detector



## 7.4. Menu Mode Selection



The external Calibration / Configuration Keypad is used in its simplest form to calibrate the sensor for zero or gas drift.

It may also be used to configure the FGD10b.

The following features are available via the Calibration / Configuration Keypad menu system: -

Menu Option
E : 1 – Sensor Zero
E : 2 – Sensor Span
E : 4 – Output Zero (4mA)
E : 3 – Sensor FSD
E : 5 – Output Span (20mA)
E : 9 – Diagnostics
E : 12 – Cross reference
E : 19 – Positive zero suppression
E : 20 – Negative zero suppression
E : 25 – Zero temperature compensation +ve
E : 34 – Span temperature compensation +ve
E : 35 – Span temperature compensation -ve
E : 36 – Zero temperature compensation -ve
E : 77 – Firmware version

The menu options are selected as follows:

- Press the MENU button, **E: 1** appears on the display.
- Press  or  until the required menu option is displayed, see following options.
- Press  to select the menu option.
- To exit the menu press MENU.

*While the instrument is in menu mode – any data displayed on the screen will alternate between the menu number and the reading.*

# STATUS SCIENTIFIC CONTROLS

Installation, Commissioning & Routine Gas Testing  
FGD10B Pellistor Gas Detector



## 7.4.1. E : 1 – Sensor Zero







Refer to section 8.1.1. for sensor calibration details.

## 7.4.2. E : 2 – Sensor Span

Refer to section 8.1.2. for sensor calibration details.

## 7.4.3. E : 3 – Sensor Fsd

This Feature sets the FSD of the instrument. It must be matched to the sensor.

- Press MENU to open the menu system.
- Using the  or  buttons, select menu option: E:3
- Press .
- Using the  or  buttons, change the display to the required setting.
- Press  to store the new value.

Note: Pressing the MENU button rather than the  button exits without any change.

- Press MENU to close the menu system.

## 7.4.4. E : 4 – Output Zero (4mA)

Refer to section 8.2.1. for output calibration details.

## 7.4.5. E : 5 – Output Span (20mA)

Refer to section 8.2.2. for output calibration details.







# STATUS SCIENTIFIC CONTROLS

Installation, Commissioning & Routine Gas Testing  
FGD10B Pellistor Gas Detector



## 7.4.6. E : 8 – Sensor Type

There is only one type of sensor that can be fitted, that is a pellistor type device.

- Press MENU to open the menu system.
- Using the  or  buttons, select menu option: E:8
- Press .
- Using the  or  buttons, set the required sensor type.
- Press  to store the new value.

Note: Pressing the MENU button rather than the  button exits without any change.

- Press MENU to close the menu system.

**Note:** This option will restore the sensor to the factory default values. The user must perform a system calibration.

# STATUS SCIENTIFIC CONTROLS



Installation, Commissioning & Routine Gas Testing  
FGD10B Pellistor Gas Detector



## 7.4.7. E : 9 – Engineer diagnostics

This feature is a view-only feature. No configuration changes are possible from within this menu.

The information is for use of Status Scientific Controls personnel.

- From the menu system select menu option: **E: 9** and press .
- Using the  or  buttons, display the required setting. The displayed values are as follows:

E : 90	Reading
E : 91	Current sensor temperature °C
E : 92	Sensor AtoD counts
E : 96	Status flags

# STATUS SCIENTIFIC CONTROLS

Installation, Commissioning & Routine Gas Testing  
FGD10B Pellistor Gas Detector



## 7.4.8. E : 12 – Sensor cross reference

This option is used to allow the user to calibrate the sensor with a commonly available gas (e.g. methane or propane) but use the unit to detect a different gas (e.g. methanol or acetone etc.). This is achieved by adjusting the cross-reference factor according to the difference in signal that is detected for the calibration gas compared to the target gas.

- Press MENU to open the menu system.
- Select menu mode **E:12** (refer to section **Error! Reference source not found.**) and press ENTER.
- Press ENTER.
- Using the INCREASE and DECREASE buttons, set the required cross-reference factor.
- Press ENTER to store the new value.  
**Note:** Pressing MENU instead of ENTER aborts any changes (the existing factor is displayed on exit).
- Press MENU to close the menu system.

**Ask Status Scientific Controls for advice on settings.**

Some typical settings when methane is used for the calibration gas

Target gas	Xref	Comments
Methane	1.00	
Propane	1.88	
Butane	2.04	
Hexane	2.35	
Ethane	1.39	
Pentane	2.21	
Nonane	4.00	
Acetylene	1.67	
Acetone	2.21	
Xylene	3.00	
MEK	2.63	

These value are typical and must be verified by the user as to the accuracy of the readings.





# STATUS SCIENTIFIC CONTROLS

Installation, Commissioning & Routine Gas Testing  
FGD10B Pellistor Gas Detector



## 7.4.9. E : 19 – Positive Zero Suppression

This option is used to allow the user to suppress small amounts of positive sensor zero drift. The setting can be set between 0 and 10% of the sensor range as set by the FSD value.







- Press MENU to open the menu system.
- Using the  or  buttons, select menu option: **E:19**
- Press .
- Using the  or  buttons, set the required zero suppression value.
- Press ENTER to store the new value.

Note: Pressing the MENU button rather than the R button exits without any change.

- Press MENU to close the menu system.

## 7.4.10. E : 20 – Negative Zero Suppression

This option is used to allow the user to suppress small amounts of negative sensor zero drift. The setting can be set between 0 and -10% of the sensor range as set by the FSD value.

- Press MENU to open the menu system.
- Using the  or  buttons, select menu option: **E:20**
- Press .
- Using the  or  buttons, set the required zero suppression value.
- Press  to store the new value.

Note: Pressing the MENU button rather than the  button exits without any change.

- Press MENU to close the menu system.

# STATUS SCIENTIFIC CONTROLS

Installation, Commissioning & Routine Gas Testing  
FGD10B Pellistor Gas Detector



## **7.4.11. E : 25 – Positive Zero Temperature Compensation**

This option has no effect on the sensor version 1.0.3

## **7.4.12. E : 34 – Positive Span Temperature Compensation**

This option has no effect on the sensor version 1.0.3

## **7.4.13. E : 35 – Negative Span Temperature Compensation**

This option has no effect on the sensor version 1.0.3

## **7.4.14. E : 36 – Positive Zero Temperature Compensation**

This option has no effect on the sensor version 1.0.3.

## **7.4.15. E : 77 – Firmware Version**

The FGD10b Firmware version is displayed.

- Press MENU to close the menu system.

# STATUS SCIENTIFIC CONTROLS

Installation, Commissioning & Routine Gas Testing  
FGD10B Pellistor Gas Detector





## 8. CALIBRATION

### 8.1. Sensor Calibration

This feature allows the sensor to be calibrated. Ensure that the correct sensor type is selected in the configuration prior to calibration. Refer to section 7.4. for details of the menu system operation.





Note: if the password is in operation then the user will be prompted with PASS when ever the menu key is pressed. Pressing the MENU key again will result in the restricted user access, i.e. only the zero and span options will be available. Entering the correct password will give access to the full menu facility.

#### 8.1.1. Sensor Zero

- From the menu system select menu option: **E: 1** and press .
- Ensure the sensor is in a zero-gas environment.  
**Note: Where a purging gas has to be applied, use a flow rate of between 500 and 1000cc/min. Allow sufficient time for the sensor to respond.**
- Press  to zero the sensor, '---' will be displayed to confirm the sensor zero has been performed.  
**Note: Pressing MENU rather than  exits the zero feature without performing the calibration.**
- Press MENU to close the menu system.  
**Note: The ZERO factor will be displayed momentarily on exit.**

## 8.1.2. Sensor Span

Always zero the sensor prior to performing a span operation.

- From the menu system select menu option: **E: 2** and press .
- Apply a known concentration of gas (applicable to sensor type) at a flow rate of between 500 and 1000cc/min. Allow time for the sensor to respond.
- Using the  and  buttons, set the reading to that of the calibration gas level.
- Press  to span the sensor, '----' will be displayed to confirm the sensor span has been performed.

**Note: pressing MENU rather than ENTER exits the span feature without performing the calibration.**

Wait until the reading is stable, if necessary press  again to span the sensor.

- Press MENU to close the menu system.
- **Note: the SPAN factor will be displayed momentarily on exit.**
- Turn off and disconnect the calibration gas.

## 8.2. Analogue Output Calibration

The analogue output is that of a current source. In order to calibrate the output it is necessary to monitor the output signal. This can be performed in one of two ways:

### Current measurement:

Connect an ammeter (or multimeter set to measure current in the mA range) in series with the analogue output.



Advantage: Direct measurement of output.

Disadvantage: The analogue output has to be disconnected to allow the connection of the meter.

### Voltage measurement:



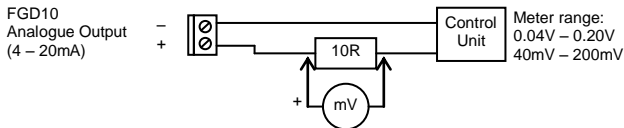

Permanently connect a 10R resistor in series with the analogue output. When calibration is required, connect a voltmeter (or multimeter set to measure voltage in the mV range) across the 10R resistor.



Advantage: No need to disturb wiring between FGD10B and control unit.

Disadvantage: Measurement accuracy dependent upon resistor tolerance.

## 8.2.1. Analogue Output Zero

- Monitor the current sourced from the analogue output of the FGD10B using a suitable method.
- From the menu system select menu option: **E: 4** and press .
- Using the  and  buttons; adjust the output to the required level (4mA or 40mV).
- Press .





Note: Pressing MENU rather than  exits the zero feature without performing the calibration.

- Press MENU to close the menu system.

Note: The ZERO factor will be displayed momentarily on exit.

## 8.2.2. Analogue Output Span

Always zero the analogue output prior to performing a span operation.

- From the menu system select menu option: **E: 5** and press  (button 4).
- Using the  and  buttons; adjust the output to the required level.
- Press .

Note: Pressing MENU rather than  exits the span feature without performing the calibration.

- Press MENU to close the menu system.

Note: The ANALOGUE OUTPUT SPAN factor will be displayed momentarily on exit.

# STATUS SCIENTIFIC CONTROLS

Installation, Commissioning & Routine Gas Testing  
FGD10B Pellistor Gas Detector



## 9. ROUTINE GAS TESTING

Refer to Figure 7, which shows the arrangement for applying the test gas to the FGD10B.

1. Before application of the test gas, check that the associated control panel reads zero with no known gas present in the atmosphere. If necessary, carry out adjustment of the zero setting as described in section Sensor Zero.
2. Apply the test gas and allow a sufficient time for the sample to reach the gas detector. The response time will vary according to the length of the sampling tube.
3. **Record the time taken** for the gas detector to provide a reading of 90% ( $T_{90}$ ) of its final value (e.g. to reach 45ppm when using a 50ppm  $H_2S$  test gas). This reading should be retained for future reference as it can provide an indication of the health of the sinter (flame arrestor). This is situated in the base of sensor housing and it is through this device that the gas passes in order to reach the sensor itself. If necessary, carry out adjustment of the span setting as described in section 8.1.2. .

Carrying out the above procedure, and comparing the results with previous readings, will confirm that the FGD10B is functioning correctly, both physically and electrically.

In the unlikely event that the response time is seen to be increasing, when comparing periodic readings, it is advisable to change the unit so that it can be checked.

The period between carrying out routine gas testing shall be in accordance with the customer's specification.

# STATUS SCIENTIFIC CONTROLS

Installation, Commissioning & Routine Gas Testing  
FGD10B Pellistor Gas Detector



## 10. SENSOR REPLACEMENT

### 10.1. Pellistor sensor

#### Step 1

Turn cover securing stud clockwise to allow cover to open.

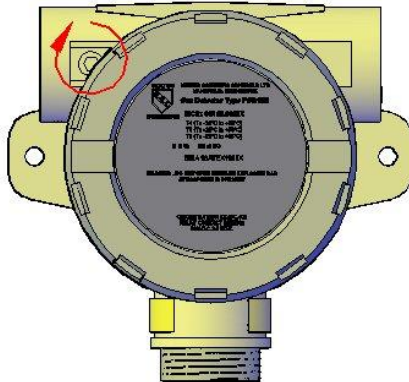

#### Step 2

Remove cover by rotating anti-clockwise

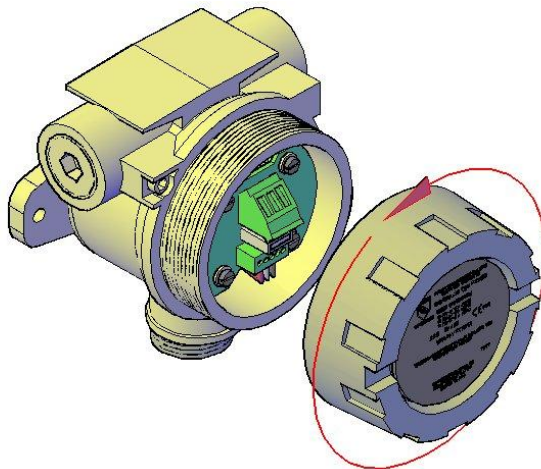

# STATUS SCIENTIFIC CONTROLS

Installation, Commissioning & Routine Gas Testing  
FGD10B Pellistor Gas Detector



## Step 3

Remove the main PCB and unplug the pellistor sensor board.

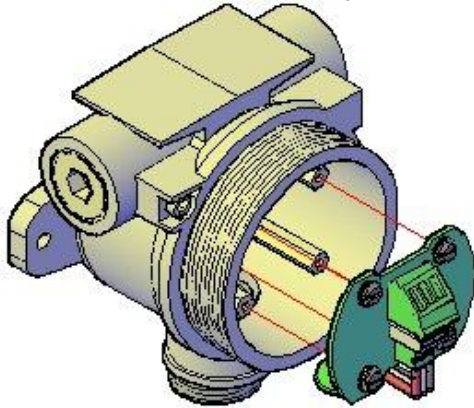

## Step 4

Remove sensor insert using extraction tool

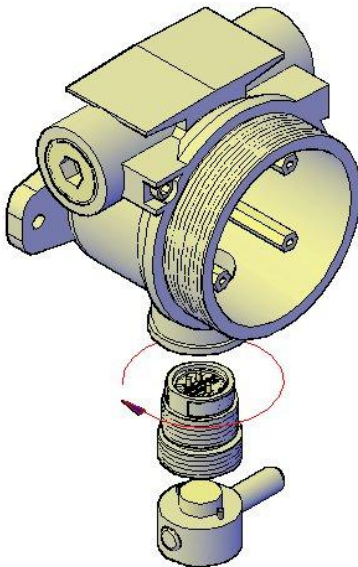

# STATUS SCIENTIFIC CONTROLS

Installation, Commissioning & Routine Gas Testing  
FGD10B Pellistor Gas Detector



## Step 5

Undo the circlip that retains the sensor in its housing. And replace the sensor.

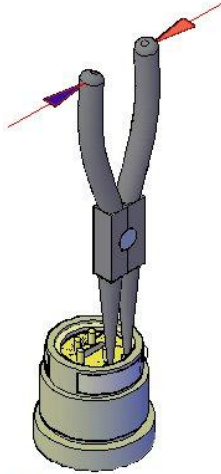

## Step 6

Apply Loctite 243 or a compound equal strength to the threads. Insert the sensor housing into the FGD10B enclosure using the insertion tool.

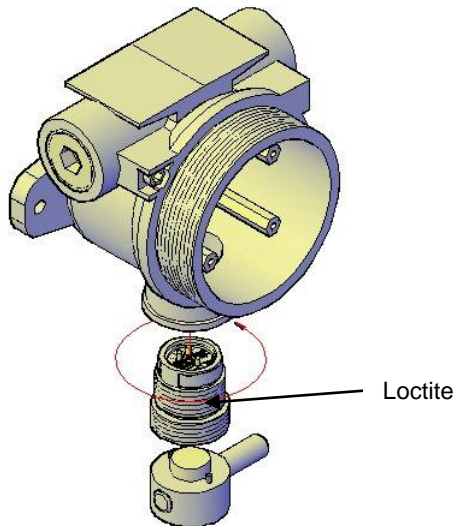

# STATUS SCIENTIFIC CONTROLS

Installation, Commissioning & Routine Gas Testing

FGD10B Pellistor Gas Detector



## Step 7

Place the pellistor sensor board onto the pellistor sensor pins and fix the pellistor main board into position.

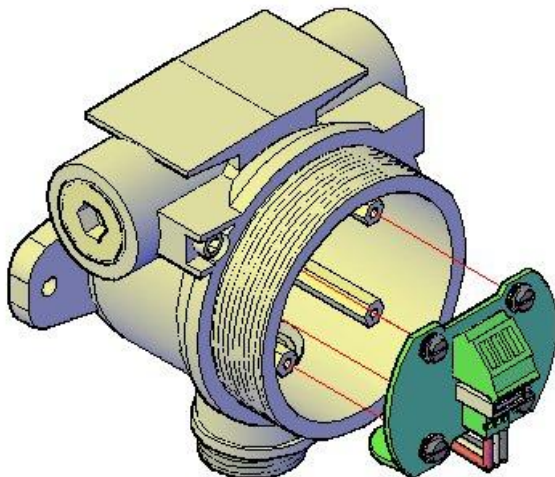

## Step 8

Replace cover and fully tighten.

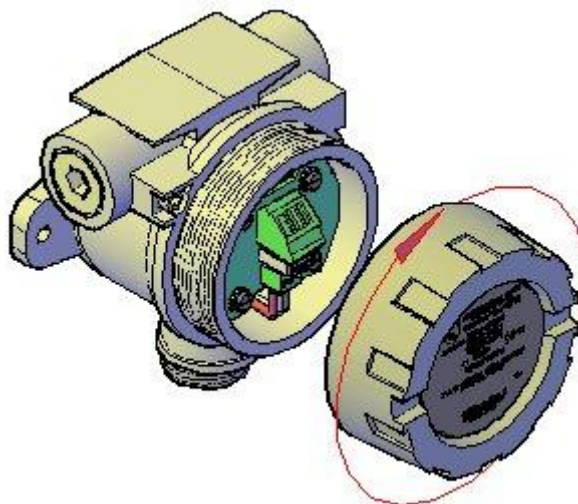

# STATUS SCIENTIFIC CONTROLS

Installation, Commissioning & Routine Gas Testing  
FGD10B Pellistor Gas Detector



## Step 9

Turn the cover securing stud anti clockwise until the stud is in tight contact with the cover.

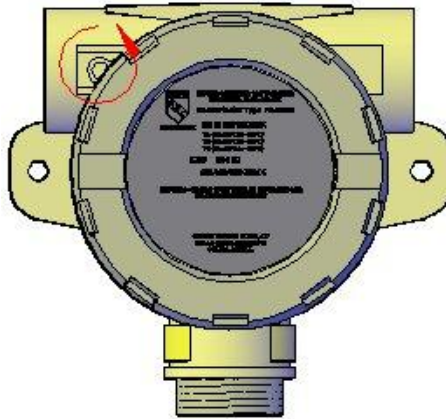

# STATUS SCIENTIFIC CONTROLS

Installation, Commissioning & Routine Gas Testing

FGD10B Pellistor Gas Detector



## 11. FUSES

A 340 mA polyfuse is located within the FGD10B. It will automatically reset when normal conditions return.

## 12. SPECIFICATION

<b>Materials</b>	: Instrument Body – Aluminium Pressure Die Casting : Sensor Insert – Stainless Steel Grade 316 Weather guard – Stainless Steel Grade 304 & Nylon 66
<b>Cable entries</b>	: 2 x 20mm or 2 x ½NPT or 2 x ¼ NPT
<b>Weights</b>	: FGD10B (excluding weather guard) – 0.75Kg Weather guard – 200 grams
<b>Sensor type</b>	: Electrochemical
<b>Input voltage</b>	: 8 to 24 volts dc
<b>Input power</b>	: 5 Watts maximum
<b>Internal fuse</b>	: 340mA 'Nanofuse'
<b>Analogue output</b>	: 4 to 20mA (10 bit resolution)
<b>Comms output</b>	: Communications with hand-held calibration keypad at 38400 baud (3V logic)
<b>Measurement range</b>	: Depends upon sensor type
<b>Response time</b>	: Typically T <sub>90</sub> < 40 sec, depends upon sensor type
<b>IP rating</b>	: Enclosure IP68, Sensor IP65
<b>Display / Keypad</b>	: External via internal connector
<b>Operating temperature</b>	: - 20 to +60 °C
<b>Humidity range</b>	: 0 to 95% RH non-condensing
<b>Operating pressure</b>	: Atmospheric + or - 10%
<b>Performance standards</b>	: EN 61779-1:2000, EN 61779-4:2000, EN 61779-5:2000

# STATUS SCIENTIFIC CONTROLS

Installation, Commissioning & Routine Gas Testing  
FGD10B Pellistor Gas Detector



## 13. DIMENSIONS

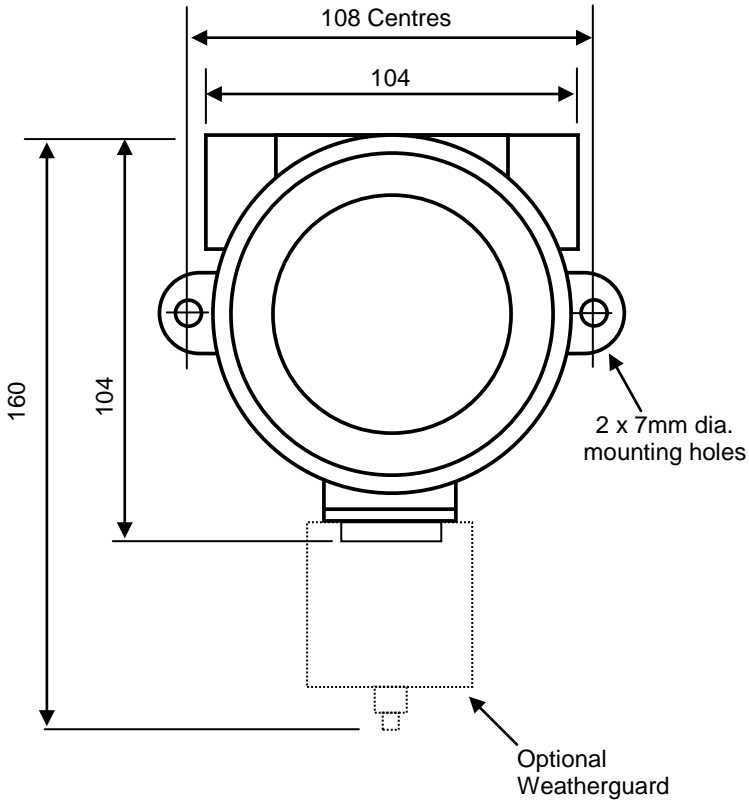

Maximum Depth = 127mm

# STATUS SCIENTIFIC CONTROLS

Installation, Commissioning & Routine Gas Testing  
FGD10B Pellistor Gas Detector



## 14. CERTIFICATION

The FGD10 Series of Gas Detectors are ATEX and IECEx certified for use in potentially explosive atmospheres and is marked as follows:-

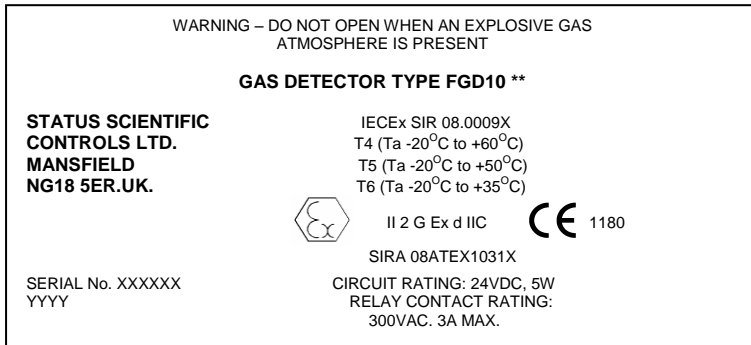

\*\* Denotes additional characters that define the gas detector configuration e.g. Enclosure type and sensor arrangement.

YYYY – Denotes year of manufacture.

### Special Conditions of Safe Use

1. The gap between the SI-IR sensor and its housing in the gas detector is 0.11mm maximum and should not be enlarged during maintenance etc.
2. Only Loctite 243 or a compound equal strength shall be re-applied to the threads of the type SI-M sensor after replacing the sensing element.
3. The SI-IR sensors shall not be installed or removed when an explosive gas atmosphere is present.

# STATUS SCIENTIFIC CONTROLS

Installation, Commissioning & Routine Gas Testing  
FGD10B Pellistor Gas Detector



Compliance with the Essential Health and Safety Requirements has been assured by compliance with:

**EN 60079-0: 2006**

**EN 60079-1 : 2007**

## **Electrical data**

Power supply - 8Vdc to 24Vdc, 5W

## **Installation instructions**

The cable entry devices and blanking elements of unused apertures shall be of a certified flameproof type, suitable for the conditions of use and correctly installed.

With the use of conduit, a suitable certified sealing device such as a stopping box with compound shall be provided immediately at the entrance to the flameproof enclosure.

A copy of the certificate is available for download from:-

[www.status-scientific.com](http://www.status-scientific.com)

# STATUS SCIENTIFIC CONTROLS

Installation, Commissioning & Routine Gas Testing

FGD10B Pellistor Gas Detector



## CUSTOMER NOTES

# STATUS SCIENTIFIC CONTROLS

Installation, Commissioning & Routine Gas Testing

FGD10B Pellistor Gas Detector

