



Rapidox 1100 Oxygen Analyser

Instruction Manual

Revision 1.0

**Cambridge Sensotec Limited
31 Elizabeth Court
St Ives
CAMBS
PE27 5BQ**

**Tel. +44 (0)1480 385812
Fax +44 (0)1480 352529
Mobile (07866) 624236
Sales@Cambridge-Sensotec.co.uk**

Declaration of Conformity

Manufacturer: Cambridge Sensotec Limited
31 Elizabeth Court
St. Ives
CAMBS PE27 5BQ
England

Product Names: Rapidox portable oxygen gas analyser

Model Numbers: RX1100

Conform to the following specifications:

EMC: EN 61326:1998 Electrical equipment for measurement,
control and laboratory use

Declaration

I declare that the above products conform to the applicable requirements of the LVD Directive 73/23/EEC and the EMC Directive 89/336/EEC and is CE marked accordingly.

Signature:



Name: Dr. Mark Swetnam

Title: Managing Director

Company: Cambridge Sensotec Limited

Date: 1st April 2008

Contents

1.	Introduction	1
2.	Features	1
3.	Specification	2
3.1	Rapidox 1100 Dimensions.....	2
3.2	Accuracy and Precision	2
3.3	Display.....	2
3.4	Calibration	2
3.5	Operating Temperature	2
3.6	Outputs.....	2
4.	Technical Specification	3
5.	Precautions.....	3
6.	Warning	3
7.	Rapidox Operating Instructions.....	4
7.1	The Rapidox Analyser - Menu System	5
7.2	Getting Started	8
7.3	Rapidox Calibration	8
7.4	Selecting the Calibration Gases	10
7.5	Cleaning the Sensor	10
7.6	Alarms	10
7.7	Analogue Outputs.....	11
7.8	Setting the Display Units.....	11
7.9	Setting the Display Options	14
7.10	Internal Pressure Sensor	14
7.11	Pressure Mode	14
7.12	Setting the Baud Rate	15
7.13	Load Defaults	15
7.14	RS232 / RS485 Port	15
7.14.1	RS232 Protocol	15
7.14.2	RS485 protocol.....	17
8.	Rapidox Software Instructions	15
8.1	Software Installation	15
8.2	Getting Started	15
8.3	On-Screen Help.....	16
8.4	Configuration Page.....	16
8.5	Reconfiguring the Analyser.....	17
8.5.1	Config 1 Screen.....	18
8.5.2	Config 2 Screen.....	19
8.6	On-Screen LCD	21
8.7	Remote Calibrating and Cleaning.....	21
8.8	Setting Analyser Date and Time	21
9.	Rapidox Data-Logging Software	22
9.1	Introduction.....	22
9.2	Setting up the Data Logger.....	22
9.3	Running the Data Logger.....	23
9.4	Auto Date Stamped Files.....	23
9.5	Live Time Graphing Screen	24
9.6	Main Graph Window	25
9.7	Plot Colours	25
9.8	Graph Titles and Labels.....	26

Cambridge Sensotec Rapidox 1100 Oxygen Analyser Instruction Manual

9.9	Plot Co-ordinates	26
9.10	Last data point	26
9.11	Using the Cursor	26
9.12	Zooming	27
9.13	Y-Axis Graph Units	27
9.14	Oxygen Scale	27
9.15	Second Y Axis	27
9.16	Loading an Old Run	28
9.17	Printing Graphs	28
9.18	Data Logging in the Background	28
9.19	Pausing the Data Logging	28
9.20	Changing the Data Logging Parameters Mid-run	28
9.21	Working with Spreadsheets	29
9.22	Disaster Recovery	29
9.23	Diagnostics	29
10.	Troubleshooting	30
11.	Warranty	32
11.1	Conditions of Warranty:	32

Cambridge Sensotec Rapidox 1100 Oxygen Analyser Instruction Manual

1. Introduction

The Rapidox 1100 oxygen analyser allows fast and accurate oxygen analysis over the oxygen range 1ppm to 100% O₂. The analyser provides continuous on-line oxygen analysis, with a typical response time of less than 4 seconds for a 90% response to a step change in gas compositions.

The Rapidox 1100 is a fully integral unit complete with a powerful diaphragm pump to provide gas sampling at approximately 1 litre per minute.

The sensor head is located inside the analyser and comprises a zirconia ceramic tube that needs to be heated to 650°C before it will conduct oxygen ions. The analyser supplies heat to the sensor, which is controlled very accurately by a regulated power supply incorporated in the instrument. An internally mounted pressure sensor compensates for any fluctuations in pressure or vacuum caused by differing flow conditions.

The analyser is packed with features including programmable alarm circuits, programmable analogue outputs, easy calibration (user selectable gases), RS232 communications and complete communications / data-logging software.

2. Features

- ✓ Very fast measurement response (typically 1-4 seconds for a 90% response).
- ✓ Wide measurement range available (1ppm to 100% O₂).
- ✓ High accuracy maintained throughout the measurement range. Accuracy $\pm 1\%$ of the actual measured oxygen with a precision of $\pm 0.5\%$.
- ✓ Easy calibration procedure requiring any two gas mixtures (ordinary room air is usually one).
- ✓ Low maintenance, sensor life expectancy typically 35,000 hours
- ✓ Powerful diaphragm pump fitted for sampling the gas
- ✓ Large back-lit LCD display (16 x 2 characters).
- ✓ RS232, 0-10V and 4-20mA current loop outputs (both programmable).
- ✓ Fully programmable alarm circuits (high and low conditions).
- ✓ Full data-logging software accessed via RS232 connection to a PC (RS485 available on request).

3. Specification

3.1 *Rapidox 1100 Dimensions*

Case dimensions: W=250mm; D=263mm; H=150mm. Weight=5kg. Power supply is factory set on ordering: 47-63 Hz Power 100VAC, 120VAC 220VAC, 240VAC. Metal carrying handle supplied.

3.2 *Accuracy and Precision*

Sensor response time is typically 1 second for a 90% response involving a step change in composition. A change between 21% and 100% can be recorded in less than 4 seconds depending on flow rates. High accuracy is maintained between calibration points. Accuracy is $\pm 1\%$ of the actual measured oxygen content with a precision better than $\pm 0.5\%$. Outside the calibration range accuracy is typically $\pm 2.5\%$.

3.3 *Display*

The analyser has a 2-line 16x2, 9mm character, back-lit liquid crystal display (LCD), whose data update rate is user-programmable. The LCD displays four significant figures of oxygen (O₂). The display notation (percent, ppm, exponential or 'automatic') is user selectable.

3.4 *Calibration*

The simple and fully flexible calibration procedure requires two calibration gases (ambient air 20.95% is normally used as calibration gas no. 1). The calibration gas compositions are user-selectable and programmed into the Rapidox via the keypad menu or the RS232 link and configuration software. Factory pre-sets can be reloaded to allow the unit to be 'rescued' from a failed calibration. The Rapidox is calibrated using the keypad on the front panel or directly with the software provided. The LCD changes to calibrate mode to inform the user of progress.

3.5 *Operating Temperature*

Gas inlet temperature must not exceed 60°C. The Rapidox unit's normal operating temperature is 5-35°C.

3.6 *Outputs*

The RS232 serial port (RS485 is available on request) outputs on demand values for oxygen (ppm), pressure (mbar), time (hh:mm:ss) and date (dd/mm/yy). This data can be downloaded and logged using the software provided.

Standard 0-10V and 4-20mA analogue outputs are available on the rear panel for both O₂ and pressure, as are 10V (logic level) O₂ alarm signals (High and Low conditions). These outputs are fully user-programmable via the front keypad or RS232 link and the supplied configuration software.

4. Technical Specification

Property	Specification
Supply Voltage	110-115 or 220-240Vac (factory set) 50/60 Hz
Power consumption	100W (max)
Analyser dimensions	250mm X 263mm X 150mm
Weight	3 kg
Display	16 × 2 character (9mm) back lit LCD
Warm up time	3-4 minutes at 20°C
Normal operating temperature	5-35°C
Outputs: O ₂ & pressure	0-10V (user-programmable) into minimum 5kΩ
O ₂ & pressure	4-20mA current loop (user-programmable) into maximum 500Ω
O ₂ high and low alarms	Relay circuits
All data and parameters	RS232 or RS485 - data streamed on demand
Sample Pump	Mains type diaphragm vacuum pump
Maximum Free Air Displacement	1.3 L.min ⁻¹
Max. gas temperature on input	60°C
Calibration	Requires 2 user-selectable gas compositions (air is default plus another)

5. Precautions

Make sure you read and understand these instructions and keep them safe for later use. The unit should not be exposed to extreme temperatures < -5°C or > 60°C. Normal operating temperature is 5-35°C. Avoid direct sunlight. Do not use liquid cleaners, aerosols or solvents to clean the case. Use a damp cloth for cleaning. Do not use this equipment near water. Avoid touching the LCD display as this may cause permanent damage. Make sure the rear ventilation slots and the fan on the rear panel are free of obstruction.

There are no user serviceable parts in this unit. Do not attempt to repair yourself. Refer all servicing to qualified Cambridge Sensotec personnel.

6. Warning

This unit is NOT designed for use in life support situations. No responsibility can be held for injury or loss of life caused by inappropriate use of this equipment.

7. Rapidox Operating Instructions

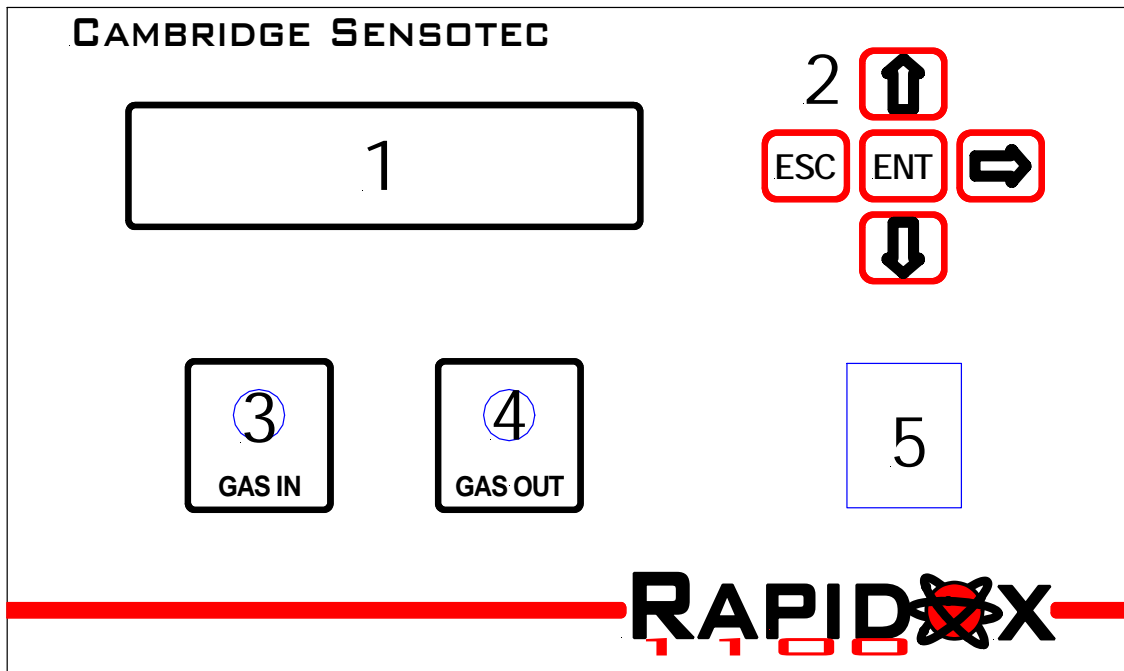

Figure 1: Rapidox 1100 front panel. Numbers are referred to in the text.

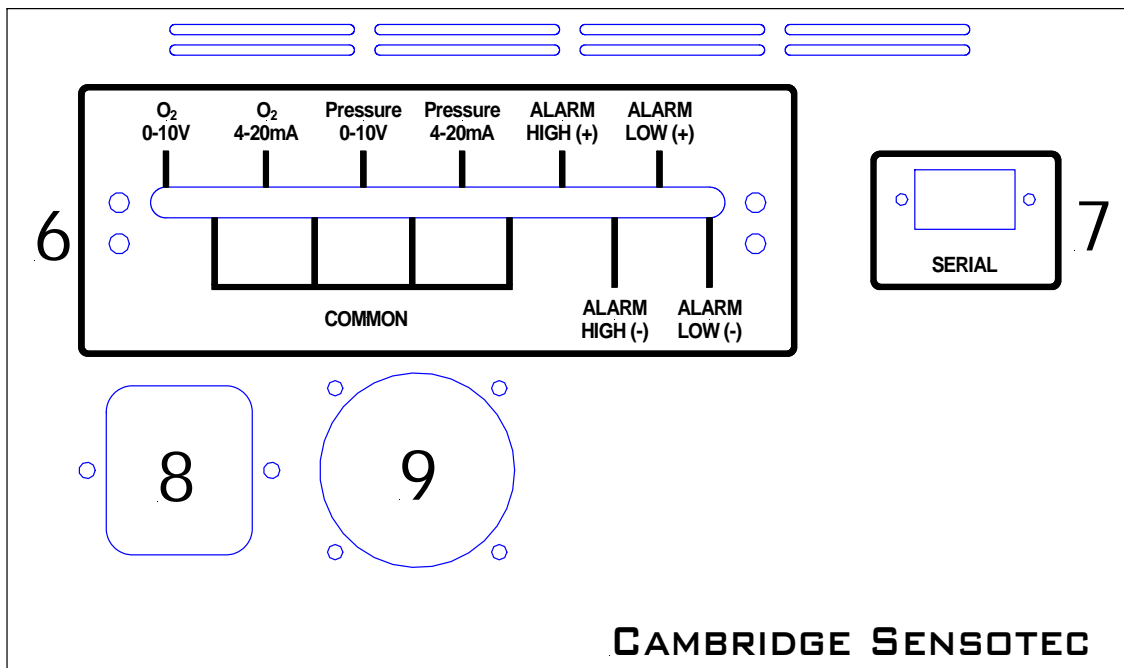

Figure 2: Rapidox 1100 rear panel. Numbers are referred to in the text.

Cambridge Sensotec Rapidox 1100 Oxygen Analyser Instruction Manual

7.1 *The Rapidox Analyser - Menu System*

All of the user-programmable functions are accessed via a menu system which is controlled using the front panel Keypad (2). To access the menu press the ENT button and to escape and return to the operating screen press ESC at any time. The menu system flow chart is shown below:

Rapidox 1100 Menu Flow Chart (FW v 8.7x)

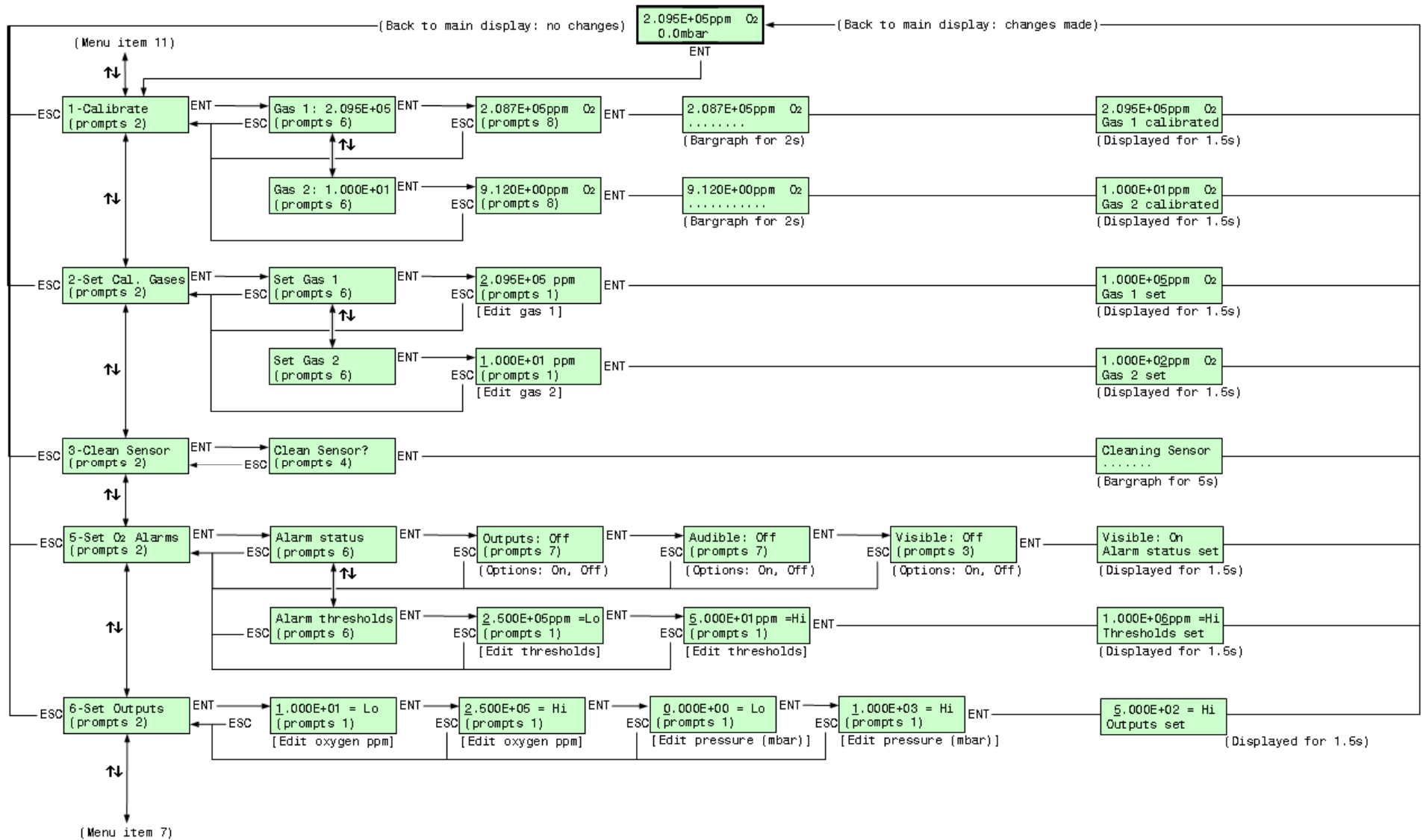

Prompts 1:
 → = Select Char.
 ↑↓ = Change
 ENT = OK
 ESC = Back

Prompts 2:
 ESC = Exit
 ↑↓ = Scroll Menu
 ENT = Next

Prompts 3:
 ↑↓ = Change
 ENT = OK
 ESC = Back

Prompts 4:
 ENT = OK
 ESC = Back

Prompts 5:
 → = Select Char.
 ENT = OK
 ESC = Back
 ↑↓ = Change

Prompts 6:
 ESC = Back
 ↑↓ = Scroll Menu
 ENT = Next

Prompts 7:
 ↑↓ = Change
 ESC = Back
 ENT = Next

Prompts 8:
 ESC = Back
 ENT for 2s = OK

Rapidox 1100 Menu Flow Chart (continued)

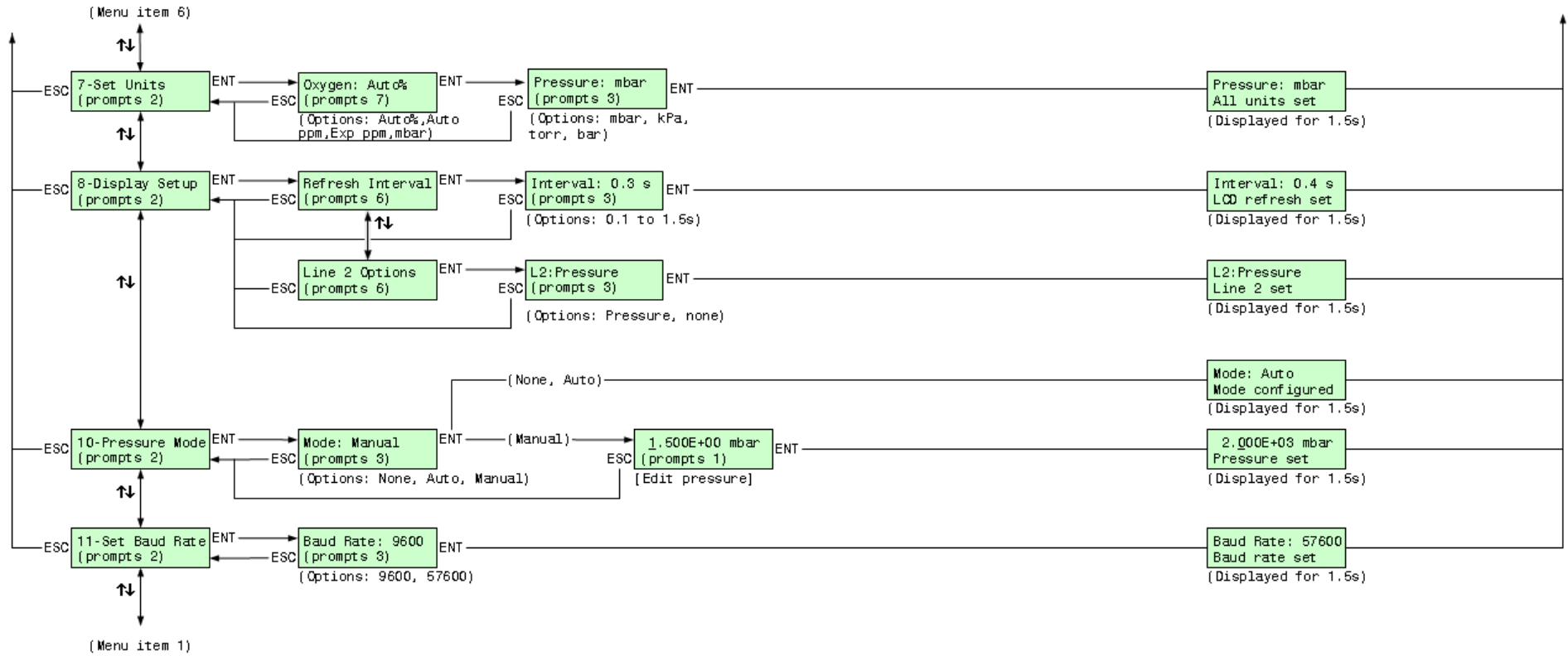

Prompts 1:
 → = Select Char.
 ENT = OK
 ESC = Back
 ↑↓ = Change

Prompts 2:
 ENT = Enter
 ESC = Exit
 ↑↓ = Scroll Menu

Prompts 3:
 ENT = OK
 ESC = Back
 ↑↓ = Change

Prompts 4:
 ENT = OK
 ESC = Back

Prompts 5:
 → = Select Char.
 ENT = OK
 ESC = Back
 ↑↓ = On/Off

Prompts 6:
 ESC = Back
 ↑↓ = Scroll Menu
 ENT = Next

Prompts 7:
 ↑↓ = Change
 ESC = Back
 ENT = Next

Prompts 8:
 ESC = Back
 ENT for 2s = OK

Cambridge Sensotec Rapidox 1100 Oxygen Analyser Instruction Manual

7.2 *Getting Started*

Ensure that the Rapidox analyser is located away from extreme heat and dirt environments. Plug the unit in to a suitable supply (noting the information on the serial sticker and using the power cable supplied) using the rear power socket (8). Make sure that the cooling fan (9) is not obstructed during operation.

Push the gas sample tube (6mm OD/4mm ID) to the GAS IN (3) connector and fit the retaining collar hand tight. Repeat for the GAS OUT (4) connector should an outlet tube be required.

Turn the unit on using the red power switch on the front (5). The LCD (1) will display the firmware version followed by the message "HEATING SENSOR". The sensor will take approximately four minutes to come up to temperature, after which the Rapidox will begin to take measurements. The progress of the sensor heater is shown in the form of a bar graph on the LCD (1). Once at temperature the LCD display will show the oxygen reading and the pressure. The word *ALARM* may appear to the bottom right of the LCD if the alarm system is enabled and an alarm condition applies.

Allow thirty minutes for the box to stabilise fully. This allows the components of the analyser to reach a stable working temperature. During this warm-up period it is common for the baseline oxygen to drift by a small amount, which may be corrected by re-calibrating.

7.3 *Rapidox Calibration*

Once the unit is at temperature it may be necessary to calibrate the sensor. Full calibration is a simple procedure requiring only two gases (one of which is normally air – 20.95%). The two gas values are user-selectable and can be changed by using the front keypad (2) or the communications software described in section 8, and the calibration values can be stored on file for later use.

Care must be taken to calibrate the analyser so that, whenever possible, the range of measurement lies between the two calibration points. For example, if you are working at 10ppm but have calibrated the analyser between 21% and 100% then the analyser will be inaccurate. You would need to calibrate at, say, 1ppm and 21% to be sure of good accuracy. The procedure is as follows:

- 1) Bearing in mind the points made above decide which two gases you are going to use for calibration. If you are constantly working at a particular range of compositions then it would be wise to obtain small cylinders of calibration gas with analysis certificates. You may need to programme the analyser and tell it which two gases you are using. This procedure is necessary only when you change calibration gases and is explained in section 7.4.

Cambridge Sensotec Rapidox 1100 Oxygen Analyser Instruction Manual

- 2) Press the 'ENT' button on the front panel keypad (2) to access the menu system. The calibration function is the first item on the menu list which can be scrolled using the up and down arrows. Press ENT again to enter the calibration menu. Use the UP and DOWN arrows to select either GAS 1 or GAS 2 and press ENT to proceed. The top line of the display shows the gas selected and the bottom line of the display shows the prompts. If either GAS 1 or Gas 2 are not what you require you need to reprogram the cal gases using the procedure described in 7.4.
- 3) The sensor needs to be exposed to the first calibration gas from a cylinder (or exposed to ambient air, 20.95% if this is the calibration gas of choice). Allow several minutes to pass to flush the sensor properly. Wait for the top line of the display (1) to become stable. To complete the calibration press and HOLD the ENT button for two seconds¹. During this time you will see a bar graph progress across the lower display. The analyser will then recalibrate and display "Gas 1 recalibrated" and then return to normal run mode. The display will now correctly read the value of the first calibration gas.
- 4) To calibrate against the second calibration gas, repeat the procedure from 2 but this time press ENT followed by the UP or DOWN button to scroll through to the second screen. The second line will display the second stored calibration gas value. Flush the sensor chamber with the second calibration gas allowing several minutes for the new gas to flush through. Wait for the display to become stable before pressing the ENT button for two seconds¹. The analyser will then recalibrate and display "Gas 2 recalibrated" and then return to normal run mode. The display will now correctly read the value of the first calibration gas.
- 5) The analyser is now correctly calibrated and will read accurately between these two calibration points. Note that this procedure can be performed remotely using the software described in section 8.
- 6) If at any time, you encounter difficulties and wish to restore the machine to its factory set calibration, use the configuration software provided and load the default settings (described in section 8.4 below). Each machine is provided with a unique file that contains the factory settings. This is located on the CD-Rom provided and is copied onto your PC during the installation process.

NB You must always perform a FULL calibration to achieve good accuracy. Only calibrate the Rapidox when in NORMAL mode and with no PRESSURE CORRECTION set (see below for details).

¹Note that if the 'ENT' button is released before two seconds have elapsed, the recalibration will be aborted and the analyser will return to run mode using the existing calibration.

7.4 *Selecting the Calibration Gases*

Any two calibration gases can be used to calibrate the Rapidox although it is recommended that one is always air (20.95%). You can reprogram the two calibration gases to suite your needs via the menu (2) on the front panel or by using the software provided (section 8.5.2). Press ENT to access the menu and scroll down to option 2 “Set Cal. Gases”. Press ENT to proceed. Use the UP and DOWN arrows to select cal gas 1 or cal gas 2. Press ENT to edit the value. On the edit screen you can use the RIGHT arrow to move the blinking cursor across to the character you wish to change². Use the UP & DOWN keys to change the value. You can also change the sign of the exponent in the same way. Note that for ease of editing the cal gases are written in ppm Exponent format so air (20.95%) would read 2.095E+05ppm. When you have finished editing the value press ENT to store it in memory. Now repeat the operation for the second cal gas. These values will remain in memory until you re-edit them in the future.

7.5 *Cleaning the Sensor*

You can clean the sensor at any time by pressing ENT on the keypad (2) and scrolling down to option 3 “Clean Sensor” or using the software described in section 8.7. Press the ENT button to proceed. The screen displays “Clean Sensor?”. Press ENT again and the cleaning will take place. The procedure takes approximately five seconds and the LCD display shows the progress of the operation. Once finished the analyser will take a moment to re-stabilise. The sensor is cleaned each time the unit is switched on prior to operation. If you are operating in gases with large amounts of soot, there is a risk that the sensor surfaces will become contaminated with particulates, which will impair performance if allowed to build up. The cleaning operation pumps oxygen through the zirconia tube, which burns the particulates away from the sensor surface.

7.6 *Alarms*

The Rapidox is fitted with fully programmable alarms. There are two independent alarm circuits for low and high oxygen conditions and the connections are made on the rear panel (6). These are relay circuits which are open if there is no alarm and closed when an alarm condition occurs³. You have the option of enabling the alarm circuits, enabling an audible buzzer and enabling a visual warning on the screen.

The alarm set points can be programmed by the user via the keypad (2) on the front panel or using the software provided (section 8.5.2). To change the alarm set point scroll down the menu to no. 5 “Set O2 Alarms” and press ENT. Now use the UP & DOWN arrows to select “Alarm Thresholds” and press ENT. The next screen shows

² Note that you can not go back to edit a previous value. Instead keep pressing the RIGHT button and the cursor will wrap around back to the beginning. Alternatively press ESC to start again.

³ Note that the alarm circuit relays are accessed via the terminal block on the rear panel and are clearly labelled. The relay circuit is rated at 24V 0.5amps maximum.

Cambridge Sensotec Rapidox 1100 Oxygen Analyser Instruction Manual

the alarm low setting which can be modified in the same way as described in 7.4. Press ENT when finished and repeat for the high alarm setting. Press ENT to finish and return to normal operation.

To modify the alarm options select menu no. 5 again and use the UP & DOWN arrows to select “Alarm Status”. Here you are given the option to enable or disable the outputs on the rear, enable or disable the audible buzzer & enable or disable the warning on the front screen. Use the UP & DOWN arrows to select each option and ENT to proceed and finish.

When the alarm is activated the warning buzzer will sound and the front display will flash the word ALARM in the lower right hand corner.

7.7 *Analogue Outputs*

The standard industrial analogue outputs (0-10V and 4-20mA) for both oxygen and pressure are accessible via the terminal block (6) on the rear panel⁴. In the case of oxygen, the outputs are factory set to provide a linear response in the range 0-25% that will cover most applications. However because of the large range of oxygen covered by the analyser, the lower and upper values are fully user-programmable using the keypad (2) or the software provided (section 8.5.2).

To modify the oxygen analogue output range scroll down the menu to no.6 “Set Outputs” and press ENT. You can now edit the lower and upper values in exactly the same manner as described in 7.4 for setting the cal gas values. Once programmed the new values remain in the memory until they are edited again in the future.

7.8 *Setting the Display Units*

The notation used by the display is fully programmable to suit your needs using the keypad (2) or the software provided. The following options are available to you:

Oxygen: The oxygen reading can be displayed in percent (e.g. 20.95%), ppm (e.g. 0.01ppm) or scientific (e.g. 2.095E+05ppm). There is also an option to display the oxygen reading in terms of a pressure in mbar. If percent is selected the Rapidox will display oxygen as a percentage down to 1% and ppm below this value.

Pressure: The internal pressure sensor reading can be displayed as mbar, bar, torr or kPa.

To program these options scroll down to menu no. 7 “Set Units” and press ENT. Use the ENT key to progress through the list and the UP & DOWN keys to select the required units. Once selected press ENT to store and return to run mode.

⁴Note that the ranges of the 0-10V and 4-20mA are tied together so changing one alters the other.

7.9 *Setting the Display Options*

The user can select the LCD refresh rate and the format of the line 2 display using the keypad or the software provided. Scroll down the menu to option no. 8 “Set up Display” and press ENT. Use the UP & DOWN arrows to select either the LCD refresh rate or Line 2 Options:

LCD Refresh Interval: The frequency of the display update can be selected from 0.1 to 1.3 seconds. The current setting can be edited using the same method as described in 7.4 for modifying the calibration gas values. Once edited press ENT to store and return to run mode.

Line 2 Options: The information displayed on line 2 of the LCD can be chosen by the user. The options are Pressure (displayed in mbar, bar, torr or KPa. Use the UP & DOWN arrows to select the display required and press ENT to store and return to normal operating mode.

7.10 *Internal Pressure Sensor*

The Rapidox 1100 is fitted with an internal pressure sensor which monitors small changes in pressure and vacuum inside the sensor head. The pressure will normally be zero mbar under normal operation but if the unit is being fed by a gas cylinder or connected to an apparatus under partial vacuum then the pressure will change and this will have a direct effect on the oxygen partial pressure and the sensor reading. You have the option of displaying the pressure reading on the LCD display (1). Select no. 8 “Set Up Display” and press ENT. Select “Line 2 Options” using the UP & DOWN arrows and press ENT. You can set the display to read Pressure or None. Select Pressure and press ENT. The display will now show the pressure reading from the internal sensor. If you want to view different units select no. 7 “Set Units” from the menu and press ENT three times to reach the pressure screen. Use the UP & DOWN arrows to select mbar, bar, torr or kPa and press ENT. The display will now show the pressure in the selected units.

7.11 *Pressure Mode*

The user has the option of using the reading from the internal pressure sensor to automatically correct for changes in gas pressure and hence oxygen pressure. A manual pressure correction value can also be used. To access this function scroll down to menu option 10. “Pressure Mode” and press ENT. The desired mode can then be selected using the UP & DOWN arrows and pressing ENT to store and proceed. The three modes available are:

Auto: This is the factory setting. If the Auto mode is selected then the Rapidox takes then reading from the pressure sensor and corrects the oxygen partial pressure to maintain a concentration reading. This allows users who are working with fluctuating pressures to maintain a ‘meaningful’ reading of oxygen concentration that will only be affected by changes in gas composition and not gas pressure.

Cambridge Sensotec Rapidox 1100 Oxygen Analyser Instruction Manual

Normal: If this mode is selected then there is no pressure correction performed on the oxygen reading. The pressure and oxygen sensor act independently. If the sensor is working in air (20.95%) and the pressure is doubled to 2 bar then the reading will also double to 41.9%. This is the correct oxygen partial pressure in air at 2 bar since there is a simple linear relationship between pressure and concentration.

7.12 Setting the Baud Rate

If you are using the software for data logging you can chose the communications speed (Baud Rate) by scrolling down the menu to no. 11 "Baud Rate" and using the UP & DOWN arrows to select either 9600 or 57,000. Press ENT button again to store and return to normal operation. The default factory setting is 57000. However if you are using an older PC you can decrease this to 9,600 to improve the reliability of the software and data communications.

7.13 Load Defaults

If you make a mistake programming the Rapidox it is possible to restore the machine back to its factory settings by loading the unique default configuration that is supplied on your software CD-rom. The default set-up can only be accessed using the software provided. Please see section 8.4 for further details.

7.14 RS232 / RS485 Port

It is possible to factory set the data communications port to either RS232 or RS485. Once configured at the factory it is not possible to change unless the unit is returned to Cambridge Sensotec Ltd.

Data from the Rapidox is sent on demand to the 9-way 'D' type socket (7) on the rear panel and can be read using a simple terminal programme such as 'HyperTerminal' in Windows, or with the user's own custom software. Alternatively a simple and convenient data-logger programme is included with the supplied software and is described in section 9 below.

7.14.1 RS232 Protocol

Oxygen data can be read from the RS232 port at the back of the Rapidox 1100. The default RS232 configuration is 57600-8-N-1, as shown in this example for COM1:

Cambridge Sensotec Rapidox 1100 Oxygen Analyser Instruction Manual

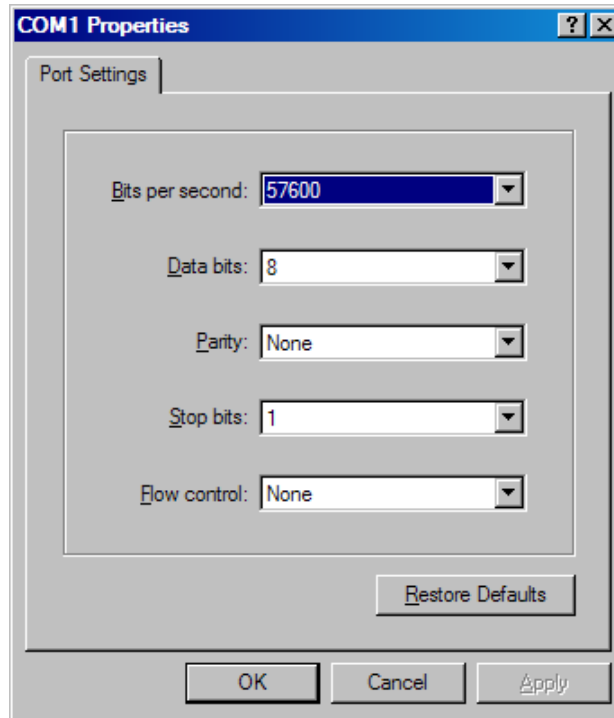

Figure 3: Rapidox default COM properties box

Alternatively, the baud rate can be reduced to 9600 via the "Baud Rate:" menu item, using the front panel keypad on the Rapidox. This setting is stored in EEPROM.

Connection: Connect to RS232 socket at the back of the Rapidox using a 9 way D-type plug. Signals are as follows:

Rapidox D-type Socket:		PC/PLC:
Pin# 2 = Data Out	→	Data In (RX)
Pin# 3 = Data In	←	Data Out (TX)
Pin# 5 = Common/Gnd	--	Common/Gnd

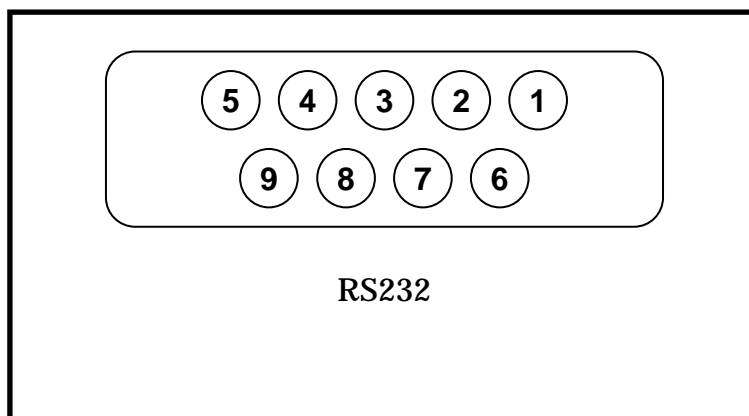

Figure 4: Rapidox RS232 pin configuration

All other pins (1,4,5,7,6,9) = Don't care

Cambridge Sensotec Rapidox 1100 Oxygen Analyser Instruction Manual

Reading Data: Data is read using command “D”. Send the single character “D” to the Rapidox. The Rapidox replies with one of the following responses. All valid responses end with [CR] & [LF] (where [CR] = ASCII 13 and [LF] = ASCII 10).

Response: !Initialising[CR][LF]

Meaning: Rapidox is still initialising

Response: !Sensor heating[CR][LF]

Meaning: Rapidox is still heating sensor to operating temperature

Response: !Cleaning sensor[CR][LF]

Meaning: Rapidox has finished heating sensor and is cleaning the sensor for 5 seconds

Response: !No sensor or sensor fault[CR][LF]

Meaning: Sensor is not connected, or there is a fault in the sensor

Response: d2.959E+05,-

1.426E+01,2.000E+00,,23:19:40,14/01/00,,,ALARM,PR[CR][LF]

Meaning: “d” means data is being sent

“2.959E+05” is Oxygen reading in ppm

“,” = data separator

“-1.426E+01” is Oxygen sensor reading in mV

“,” = data separator

“0.000E+00” is pressure sensor reading in bar

“,” = data separator

“,” = data separator

“23:19:40” is Rapidox time – ignore this

“,” = data separator

“14/01/00” is Rapidox date – ignore this

“,” = data separator

“,” = data separator

“,” = data separator

“ALARM” means Oxygen alarm is active: O2 is too high or too low **

“,” = data separator

“PR” – ignore this

[CR] = ASCII 13 (Carriage Return character)

[LF] = ASCII 10 (Line Feed character)

** If oxygen alarm is not set, this data is empty, so the response would look like:

d2.959E+05,-1.426E+01,2.000E+00,,23:19:40,14/01/00,,,PR[CR][LF]

Response: ?

Meaning: “D” command was not recognised. Try to send it again.

7.14.2 RS485 protocol

Please contact Cambridge Sensotec for further information on this new feature.

8. Rapidox Software Instructions

8.1 *Software Installation*

It is possible to program a range of variables to the Rapidox using an RS232 (or RS485 if configured) link with a PC running MS-Windows (all versions) and the supplied Rapidox software. The software is installed automatically by inserting the Rapidox CD into the CD-ROM drive. If auto-installation does not start then you can click the Windows START button and select RUN. Type X:\setup.exe where X is the drive letter of your CD. Alternatively access the CD from Windows Explorer or the 'My Computer' icon on your desktop, and double-click on the 'Setup.exe' programme. Follow the on-screen instructions to install the programme onto the hard drive. Once installed you can access the programme by clicking START - PROGRAMS – Rapidox Software⁵.

Please note that this software is generic and will work on several different machine versions. Therefore not all the functions will be enabled for your Rapidox 1100.

8.2 *Getting Started*

Make sure that the Rapidox is connected to a free serial port on the rear of your computer. These will nearly always be COM1 or COM2 but the software will scan through the ports until it finds the Rapidox. The analyser must be switched on for this to succeed and while you are communicating with it. On start up the software will locate the Rapidox and display the following page⁶:

⁵ The software has been tested successfully on most language machines including Chinese & Japanese

⁶ The values displayed in the columns of boxes above the 'Read' and 'Write' buttons may differ from those shown. NOT ALL features are available with this model.

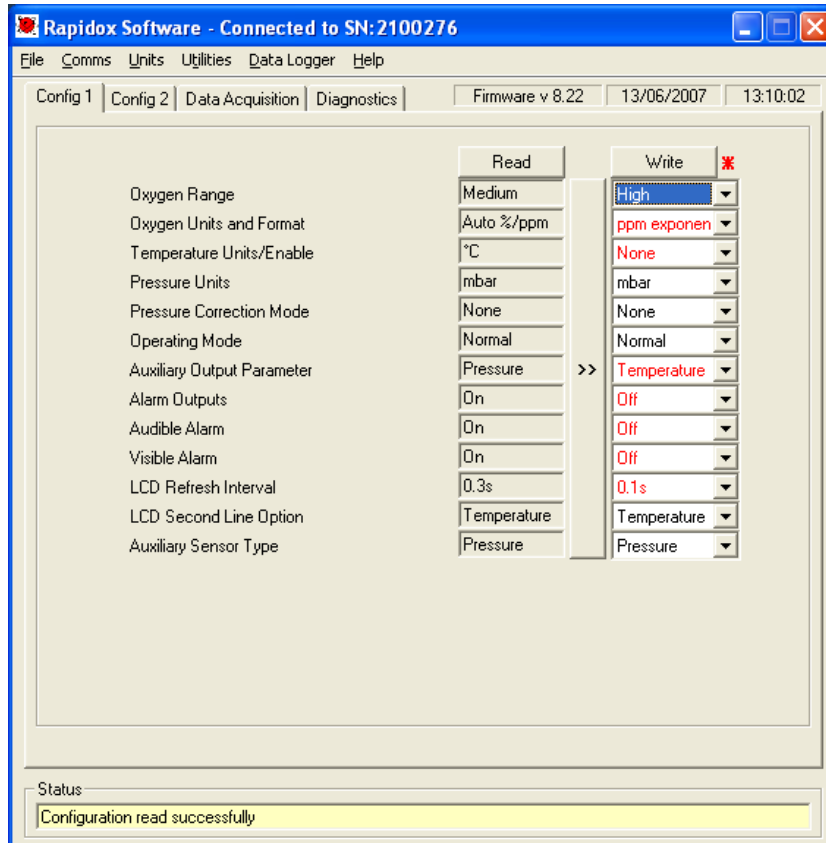

Figure 5: Rapidox configuration page

The yellow status box at the bottom will display confirmation that the Rapidox was found and the result of the last action, or any error messages if there is a problem with communication. If you experience problems check that your serial cable⁷ (supplied) is correctly fitted to a valid serial port. Also check the status of your COM port settings in Device Manager accessed by clicking START – Settings - Control Panel.

8.3 On-Screen Help

You can access the on-screen help facility at any time by clicking on the help menu on the menu bar and select the 'Help' option or press F1.

8.4 Configuration Page

The configuration page is split into two and you can toggle by clicking on the folder tabs labelled “config 1” and “config 2” page allows the user to reprogram an array of variables used by the Rapidox. Once written to the Rapidox, the new variables remain permanent until overwritten.

⁷ There are several types of serial cable available. You must use a cable as supplied where there are straight through connections, i.e., pin 2 to pin 2, pin 3 to pin 3 and pin 5 to pin 5. Other cable formats will not work.

Cambridge Sensotec Rapidox 1100 Oxygen Analyser Instruction Manual

To read the current configuration stored in your Rapidox select 'Read Analyser Configuration' from the file menu. Note that the edit boxes on the RHS will turn red if the value is different to that just read and a red asterisk will appear next to the 'Write' button to warn you that a change has been made. The left-hand set of grey text fields ('read fields') will be updated with the current configuration data. To save this information (e.g., if several people share the same instrument) press the long copy button to transfer the data into the edit boxes, select 'Save Configuration as' from the file menu and choose a filename. This data set can be subsequently be reloaded at any time by selecting 'Load Configuration File' button and selecting the directory where the configuration files have been stored.

If at any time you wish to restore the machine to its factory default settings select 'Default Configuration' from the file menu to load these values. The software will search for a unique rxc file that is loaded onto the PC during the software installation. The filename is 2100***.rxc where *** is the last three digits of the serial number located on the rear of the machine. This file is also located on the CD-Rom that came with the machine. Normally this file is located in the main Rapidox directory but if the software can not locate it then it will ask you for the serial number to help it search. With the correct rxc file loaded simply press COPY to transfer the defaults into the edit boxes and then select WRITE to load them back into the Rapidox.

The right-hand set of white editable text fields ('write fields') is used to enter new values to be programmed into the Rapidox. The values in these fields can either be entered manually, or copied across from the 'read fields' by clicking the vertical 'Copy' button, and then edited as required⁸. Alternatively, you can load saved configuration data by selecting 'Load Configuration' from the file menu and selecting the required file. In order to programme the analyser select 'Write configuration to the analyser' from the file menu.

8.5 Reconfiguring the Analyser

The on-screen edit boxes contain variables that can be reprogrammed into the Rapidox in exactly the same manner as using the front Keypad. For a full description please refer to the relevant section in this manual.

The user can choose whether to use ppm or percent notation to edit the text boxes by selecting the UNITS menu and clicking on percent or ppm. To access a field, either click inside it or use the TAB key to scroll through them. The field parameters are as follows:

⁸ Note that when you click on the copy button both pages are updated at the same time and there is no need to repeat the action when you toggle to the other page.

8.5.1 Config 1 Screen

- 1) **Oxygen Range:** Not available for the Rapidox 1100
- 2) **Oxygen Units & Format:** See Section 7.8 for a full description. Use the drop down box to select PPM EXPONENTIAL, PPM MIXED, AUTO%/PPM or PRESSURE. The default setting is AUTO%/PPM.
- 3) **Temperature Units/Enable:** Not available for the Rapidox 1100
- 4) **Pressure Units:** See sections 7.8 and 7.10 for a full description. Use the drop down menu to select MBAR, TORR or KPa as the unit for pressure measurement. The default setting is MBAR.
- 5) **Pressure Correction Mode:** See section 7.11 for a full description. Use the drop down menu to select NONE, AUTOMATIC or MANUAL. The default setting is NONE.
- 6) **Operating Mode:** Not available for the Rapidox 1100
- 7) **Auxiliary Output Parameter:** Not available for the Rapidox 1100
- 8) **Alarm Outputs:** See section 7.7 for a full description. Use the drop down menu to select OFF or ON. When set to ON the alarm circuits on the rear are activated. The default setting is ON.
- 9) **Audible Alarm:** See section 7.6 for a full description. Use the drop down menu to select OFF or ON. When set to ON the buzzer will sound when an alarm is activated. The default setting is ON.
- 10) **Visible Alarm:** See section 7.6 for a full description. Use the drop down menu to select OFF or ON. When set to ON the front display will show the word ALARM (flashing) when an alarm is activated. The default setting is ON.
- 11) **LCD Refresh interval:** Use the drop down menu to select a refresh rate for the LCD (min 0.1, max 1.5 sec). The default is 0.3 seconds.
- 12) **LCD Second Line Option:** See section 7.9 for a full description. Use the drop down menu to select PRESSURE or NONE

8.5.2 Config 2 Screen

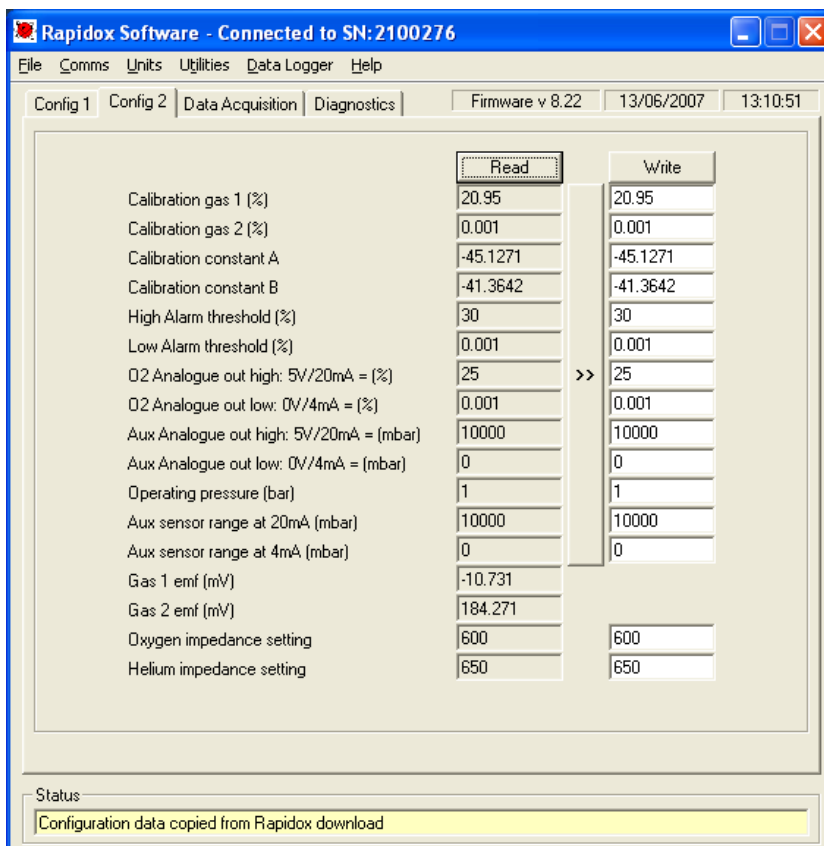

Figure 6: Configuration 2 page

- 13) **Calibration Gas 1:** Use this box to enter a new value for the first cal gas. The value can be entered either in % or ppm depending on the units selected. The default is %. Enter a value such as 10.1 for 10.1%⁹. The default value for cal gas 1 is 20.95%
- 14) **Calibration Gas 2:** Use this box to enter a new value for the second cal gas. The value can be entered either in % or ppm depending on the units selected. The default is %. Enter a value such as 0.1 for 0.1%. The default value for cal gas 2 is 0.001% (10ppm).
- 15) **Calibration Constant A & B:** These boxes contain the calibration constants that the Rapidox calculates automatically when you perform a

⁹ Note that software is 'regionally aware' and will therefore accept and display data using the decimal separator that is set in the PC's Regional Settings in the Control Panel. For example, in the UK or US, you might enter the value 2.5 - in continental Europe this would normally be entered as 2,5 assuming the PC's Regional Settings have been set up to use ',' as the decimal separator. The software also works with non-English versions of Windows including Chinese.

Cambridge Sensotec Rapidox 1100 Oxygen Analyser Instruction Manual

calibration. You will see that they change each time you perform a new calibration. It is possible to manually edit these but this should only be attempted after consulting with Cambridge Sensotec. Normally they are just provided for information and should be left untouched. The default settings are A= -46.482 and B= -38.845. Note that the values are always negative as this follows the convention of the Nernst equation.

- 16) **High & Low Alarm Thresholds:** Use these two boxes to enter new values for the alarm trigger points. The alarm High value must always be greater than the alarm low value. The value can be entered either in % or ppm depending on the units selected. The default is %. Enter a value such as 10.1 for 10.1%. The default values are 25% for Alarm High and 0.001% for Alarm Low.
- 17) **O₂ Analogue Output (0V/4mA & 10V/20mA):** Use these two boxes to set the High and Low oxygen values for the analogue outputs (6) on the rear panel. For example if you want 4mA to represent 1% and 20mA to represent 21% then enter these two values into the appropriate boxes. The value can be entered either in % or ppm depending on the units selected. The default is %. The default values are 25% for the high setting and 0.001% for the low setting.
- 18) **Operating Pressure:** Not available for the Rapidox 1100
- 19) **Gas 1 & Gas 2 emf (mV):** These values are for information purposes only and cannot be adjusted. They represent the voltage that the Rapidox measured on the sensor at the point of calibration. These values are used in the calculation of the A & B values derived from the Nernst equation. As a guide the emf in air is around -8mV and the value at 10ppm is around +190mV. Exact values depend entirely on the individual sensor.
- 20) **Oxygen and helium impedance setting:** Not available for the Rapidox 1100

Once you have finished editing the parameters, select 'Write Configuration to Analyser' from the file menu and the new data set will be written to the Rapidox. The Rapidox is reprogrammed using the new configuration. The software then reads the new settings back from the Rapidox and displays them in the boxes on the left-hand side confirming that the configuration was successful. When you have finished programming the analyser for new calibration gases you must recalibrate the instrument to benefit from the changes.

8.6 On-Screen LCD

It is possible to display an LCD emulator on the desktop of your PC. This reproduces exactly the display on the Rapidox unit and is convenient if you are some distance away from the machine. To activate the LCD select the utilities menu and select the LCD on option. This will display a small window showing the LCD that can be positioned independently anywhere on the desktop.

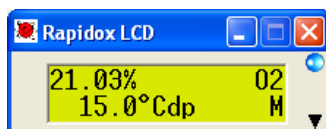

Figure 7: On-screen LCD

The blue LED indicator will flash to show that the display is updating.

8.7 Remote Calibrating and Cleaning

With the on-screen LCD display active it is possible to remotely calibrate the analyser and clean the sensor. Click on the down arrow icon in the bottom right-hand corner of the LCD display to expand the window:

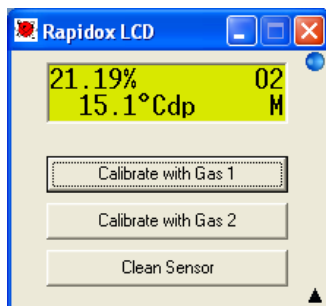

Figure 8: Remote calibration and clean function

Use the three buttons to calibrate or clean the sensor directly from the PC. Note that you will receive a prompt asking you if you wish to proceed before the calibration actually takes place.

8.8 Setting Analyser Date and Time

The current date and time of your PC are displayed on the configuration screen and can be loaded into the Rapidox by selecting the Utilities menu and clicking the 'Set date and time' option. This information is used in the RS232 data string for data logging purposes. Make sure that your PC clock is set correctly before using this function, as you cannot edit the date and time shown by the Rapidox software. The date and time formats displayed are those set in the PC's Regional Settings.

9. Rapidox Data-Logging Software

9.1 Introduction

The Rapidox software includes a full data logging facility. Data can be saved to a file automatically at regular intervals and the format is compatible with modern spreadsheet programmes such as MS-Excel. A live-time graphing facility is also included which has many powerful features. Note that the data logging facility will only function if the analyser is in NORMAL run mode.

9.2 Setting up the Data Logger

Click on the tab labelled 'Data Acquisition' to display the following page:

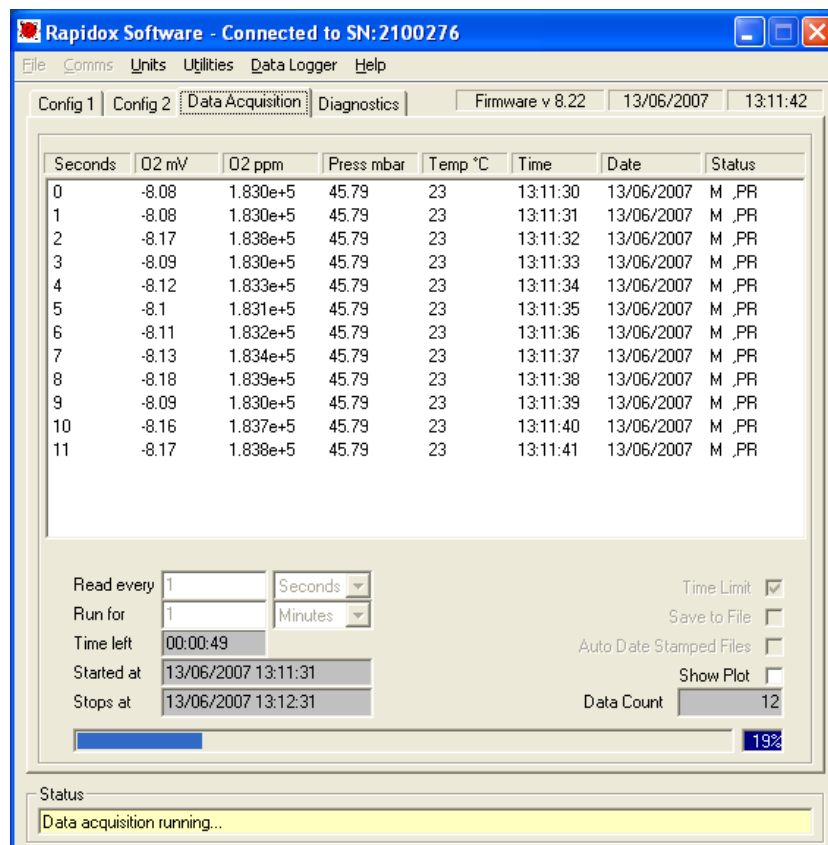

Figure 9: Data Logging page

During logging, data from the analyser is shown in the central area of this page. The data is displayed in the following columns: time (in seconds), the raw signal from the sensor (in mV), the oxygen value (in ppm scientific notation), pressure in

Cambridge Sensotec Rapidox 1100 Oxygen Analyser Instruction Manual

mbar, the time (in regional format), the date (in regional format), and status (displays the range setting or the word ALARM if the alarm is activated).

To start data logging select the frequency of measurement by entering a time and selecting a unit from the drop down list. For example if you wish to log data once every minute type 1 in the box and select 'Mins' from the drop down menu.

You can open the NOTES window at any time by selecting NOTES from the 'Data Logger' drop down menu. A small text box appears in which you can type a text message. This note is then saved as a header in the data file set and can be viewed along with the data.

You can either choose to have data logged continuously until 'Stop' is selected from the Data Logger menu, or you can choose to set a time limit for data logging by checking the box labelled 'Time Limit', setting the duration in the 'Run For' box and selecting units with the drop down list. For example if you wish to log data for thirty minutes type '30' in the box and select 'Mins' from the drop down list.

9.3 *Running the Data Logger*

If you wish to save the data into a file for later use, check the 'Save to File' box before selecting 'Run' from the Data Logger menu. You will be prompted for a file name and location before data logging commences. The file and path information will appear in the box at the top of the page labelled 'Data File Name'. If you forget to select file saving before starting a run, you will nevertheless be prompted at the end as to whether you wish to save the run data.

The blue progress bar displays the state of completion of the run, and the blue box to the right of it the same information as a percentage. You can stop the run at any time by selecting 'Stop' from the Data Logger menu. The yellow Status bar at the bottom of the page gives information about the data logging operation.

Once data logging is complete you may open the text format data file using any compatible spreadsheet programme such as MS Excel, and use the data to generate plots and reports.

You can pause the data logger at any time by selecting 'data logger' and 'pause'. Repeat to continue logging from where you left off, noting that the clock keeps ticking during the pause period.

9.4 *Auto Date Stamped Files*

If you are planning to run the data logger for extended periods of time then you should consider checking the 'Auto date stamped file' option. This feature will save the data at midnight for the previous twenty four hours and so on until the data-logging is complete OR the user interrupts. The data file is stored with a date suffix in brackets in yy-mm-dd format.

Cambridge Sensotec Rapidox 1100 Oxygen Analyser Instruction Manual

This feature ensures that data is saved periodically in sensible sized files. This will prevent the computer from crashing and will also ensure that the data is small enough to fit into an Excel spreadsheet

As an example, the user wishes to run the data-logger for seven days recording every minute starting at lunchtime on 12th November 2005. He starts the data logger with the auto-date stamp function enabled. When prompted he gives the filename as test1. In this situation the data logger will run from lunchtime to midnight and then save the first file as test1 (2005-11-12). The data logger then clears and continues for another twenty four hours until midnight the following day. The data is then stored as test1 (2005-11-13). This will continue for seven days when the data-logger will finish.

After this the user will have a sequence of files:

```
test1 (2005-11-12).txt  
test1 (2005-11-13).txt  
test1 (2005-11-14).txt
```

And so on. Combined together they represent all the data over the last seven days. Note that the Rapidox uses the computer clock and date to perform this action, so make sure that they are correct before starting a run.

To view the data in its entirety the user would need to load each file in turn back into Excel to combine.

9.5 *Live Time Graphing Screen*

The Rapidox data-logging package includes a live-time graphing facility that allows you to monitor the progress of your data in a graphical format (see Figure 10). To access the graph check the box labelled 'Show Graph'. The graph will appear in a new window, and can be accessed at any time without disturbing a run that is already in progress. You can select 'Run' and 'Stop' from the Data Logger menu to begin and end data logging, and the window can be minimised to (and restored from) the task bar while logging data.

To close the window and return to the main data-logging page select 'Close Plot' from the File menu or click on the close window button.

The features of the graph window are described below:

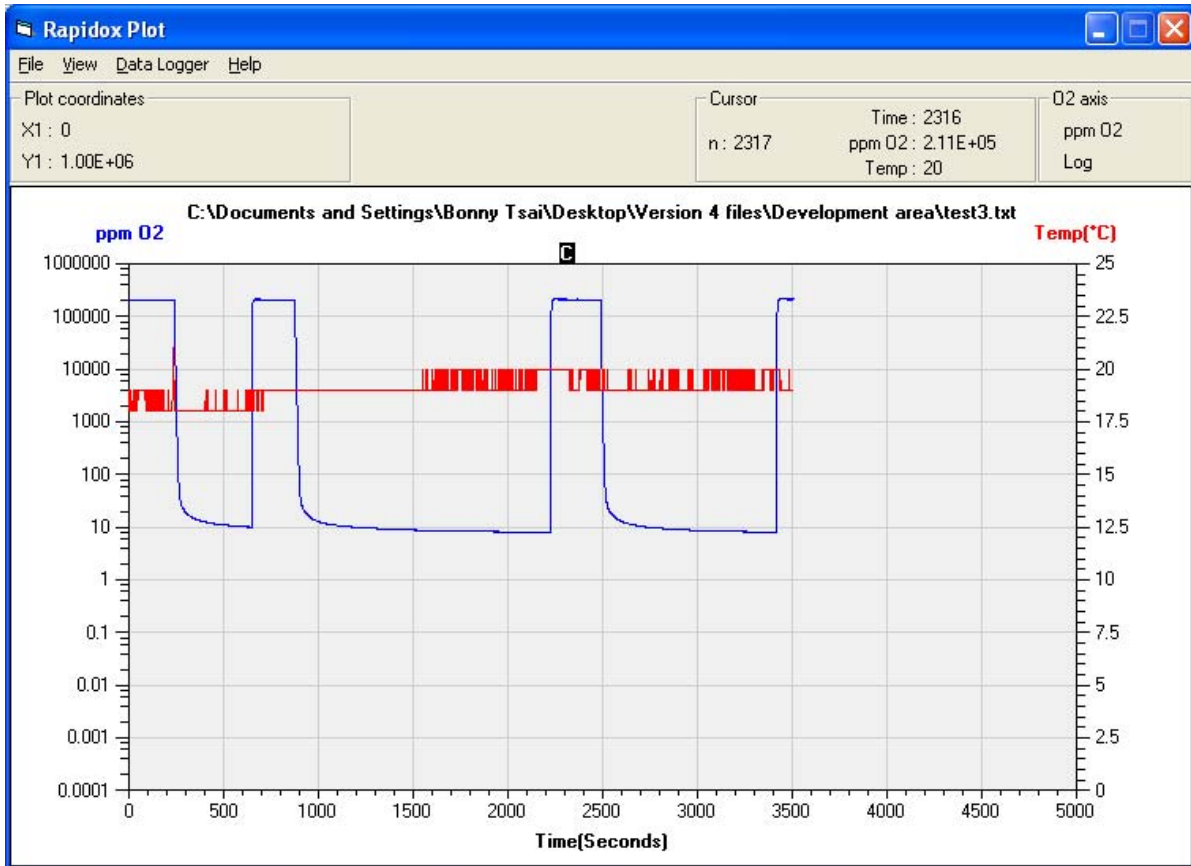

Figure 10: Live-time graphing screen

9.6 Main Graph Window

The graph is an XY plot, with time plotted on the X-axis, oxygen plotted on the primary Y-axis (Y1) and pressure plotted on the secondary Y-axis (Y2). The X-axis and the two Y-axes auto-scale during data logging so that all data points are shown on the graph.

9.7 Plot Colours

The default colours used on the graph are set to blue for oxygen and red for temperature. To change the colours double-click on the coloured axis label at the top of each axis. A colour palette window will appear (see Figure 11) and a new colour can either be chosen from a colour box, or for more variety, by clicking the 'Define Custom Colors >>' button. Click on 'OK' to select the new colour or 'Cancel' to return to the graph without change.

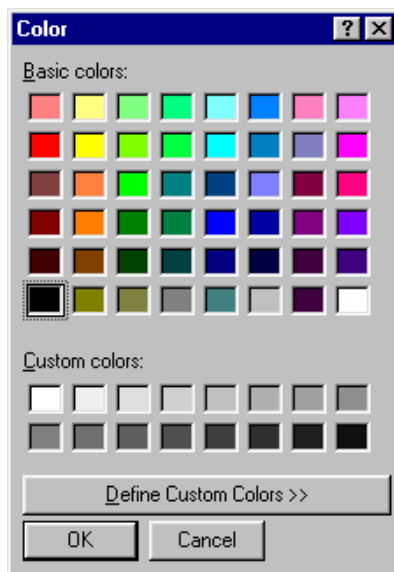

Figure 11: Plot colour palette menu accessed by double-clicking on the axes titles.

9.8 Graph Titles and Labels

If you want to change the text of the graph axis labels, place the mouse pointer over the text and do a single left click to enter edit mode. The text can then be modified. Similarly, to change the title of the graph, place the mouse pointer over the title and click once to edit. If you choose not to enter a title the graph will display the path and filename of the run as the new title once the run has finished. Note that these changes are only temporary and will be overwritten by the defaults if a new run is started or the graph window is closed and reopened. They are provided so that the plot may be printed with alternative labels.

9.9 Plot Co-ordinates

The box labelled 'Plot co-ordinates' to the upper left of the graph window displays the actual plot co-ordinate value at the mouse pointer. This can be used to get a quick oxygen value from the graph. Simply place the mouse pointer at a place of interest and read the corresponding X1 and Y1 values in the box.

9.10 Last data point

During data acquisition, the box labelled 'Last data point' will appear at the upper middle of the graph window. It displays the last data values read from the analyser.

9.11 Using the Cursor

Clicking and holding the left mouse button with the pointer over the 'C' at the top of the plot area activates the cursor, which appears as a vertical dashed line on the plot.

Cambridge Sensotec Rapidox 1100 Oxygen Analyser Instruction Manual

While keeping the mouse button pressed, you can now move the pointer anywhere in the plot area or on the  in order to move the cursor. The box labelled 'Cursor' to the upper right of the graph window will display actual values for oxygen, temperature, time and the data point number (n) at or immediately to the left of the cursor position. The cursor can be used to investigate actual data values at specific points of interest on the graph.

9.12 Zooming

You can zoom in to any part of the oxygen plot by simply placing the mouse pointer on the new graph start position and then clicking and dragging a new box to re-size the graph. The label on the box to the upper left of the graph window will change to 'Zoom box co-ordinates', and an extra set of co-ordinates, labelled X2 and Y2, will appear, showing the co-ordinates in X and Y units of the second corner of the zoom rectangle as you drag the mouse pointer. The plot will zoom and auto-scale when you release the mouse button. This can be repeated if you wish to zoom in even further. To zoom back to the original size select 'Zoom Full' from the View menu.

Note that although you can use the zoom facility during a live run, the graph will auto-scale to full size with each new data point.

9.13 Y-Axis Graph Units

You can toggle the Y1 oxygen units at any time from percent to ppm and vice versa. Select 'O2 Units' from the View menu and chose either percent or ppm. The current selection is then displayed in the top right box labelled 'O2 Axis'.

9.14 Oxygen Scale

You can display the Y1 oxygen axis in linear or logarithmic format at any time by selecting 'O2 Scale' from the view menu. The current selection is then displayed in the top right box labelled 'O2 Axis'. Note that the zoom function is disabled when you are viewing on a log scale.

9.15 Second Y Axis

The secondary Y axis located on the right hand side of the graph can be used to display either temperature taken from the type K thermocouple, pressure taken from the pressure sensor or dew-point taken from the dew-point sensor fitted to the Auxiliary socket on the front. It is not possible to display temperature and pressure / dew-point at the same time. The axis is linear and auto-scaling. To select the mode of the secondary axis select 'view' and then 'second axis display'. Choose from 'none' or 'pressure'.

9.16 Loading an Old Run

A previously logged data file can be loaded and viewed by selecting 'Open Data File' from the File menu and selecting the appropriate TXT or CSV file. A progress bar is displayed while the data is being imported. Note that very large data files may take several seconds to load. The data is re-graphed and you can zoom, label axes, change colours etc., before printing the graph.

9.17 Printing Graphs

You can print the graph at any time by selecting 'Print Plot' from the File menu. This will bring up the printer dialogue box for your specific printer where you can choose various printing options. Make sure that the printer page is set to landscape to obtain a full size print out.

9.18 Data Logging in the Background

It is possible to begin data logging and then minimise the windows to continue working with another application. To minimise the graph simply click on the minimise button on the blue title bar at the top of the window. You can then use the ALT + TAB keys to take you to other programmes already running. To return to the graph simply maximise from the start menu bar or press ALT + TAB again. If the graph does not redraw immediately select 'Zoom Full' from the View menu to redraw.

9.19 Pausing the Data Logging

You can pause the data-logging at any time during the run by selecting the 'data logger' menu and selecting 'pause'. Repeat the action to continue, noting that the live graph will draw a straight line between the paused points to keep continuity of the axes. The clock keeps ticking during the pause period.

If you decide to access the menu of the Rapidox using the front keypad during data logging, then the software will pause automatically. A message appears on the screen informing the user that the unit is being accessed from the keypad. Once the menu has been exited, the software will continue data logging from where it left off.

9.20 Changing the Data Logging Parameters Mid-run

Once the data logging has begun you may change the sample interval time by pausing the data logger and then entering a new value for the time interval. The data logger can then be resumed with the new values in place. Note that you can not change units (e.g. seconds to hours) once logging has started. If you originally selected seconds then you may change the current value to a new value between 1 and 3600 seconds, if you originally selected minutes then you may change between

Cambridge Sensotec Rapidox 1100 Oxygen Analyser Instruction Manual

0.02 and 360 and if you selected hours you may change between 0.01 and 6 hours. Note it is not possible to modify the original total length of time that the data logging will run for once a run has commenced.

9.21 Working with Spreadsheets

The data-logger saves data files in a standard comma separated ASCII text format which can be readily imported into spreadsheet programmes such as MS Excel, in order to produce plots and reports as desired. For specific information on how to import text files into your spreadsheet programme please refer to the help guide supplied with the programme.

Data is saved in comma separated value format, with a '.txt' file extension as the initial programme default. However, when entering the file name, you can instead select a '.csv' extension: the programme will register the last used file extension as the new default. The '.csv' extension is recognised by MS Excel, so that opening the file will automatically run MS Excel, and this may be of benefit if your regional decimal separator is period '.' rather than comma ','. However, if your decimal separator is comma, you should continue to use the '.txt' extension and open the file explicitly from within your spreadsheet programme, defining the field delimiter as 'comma' where appropriate.

9.22 Disaster Recovery

To prevent catastrophic loss of important data during a computer crash or power failure, the data is automatically saved point by point in a temporary file called 'Rapidox temporary data file.txt'. This file is located in the same directory as the main Rapidox programme itself and can be renamed or copied to recover data that would otherwise be lost. Note that this file is overwritten each time 'Run' is selected from the Data Logger menu so make sure all data is recovered successfully before starting another run.

Note that during a run using the 'auto date stamped' feature the temporary data file is wiped clean as soon as the previous data set has been saved successfully. In the case of a crash the temporary data file should be used to recover the last day's worth of data that was not saved to the hard disc.

9.23 Diagnostics

The Rapidox software includes a diagnostics page that is accessed from the tab labelled 'Diagnostics'. This screen will display various values and settings that are operating inside your machine. There is no editing possible on this page – it is purely for information and to enable technical support help you should you experience difficulties with your machine. You may be asked to record values from this page if trouble shooting is required.

10. Troubleshooting

- Q: The Rapidox says 'sensor heating' but won't begin measuring.
A: Check to see if the sensor is getting hot. If it is then make sure the cable plug is located firmly in the socket (2). If you are still having problems contact Cambridge Sensotec for advice. If the sensor stays cool then the internal heater has failed and the sensor needs replacing.
- Q: The Rapidox won't power up at all.
A: There are fuses located on the power socket on both live and neutral lines. These are standard 20mm (1A for 240V versions, 2A for 110V) fuses available from a supplier such as RS Components.
- Q: The Rapidox gives strange readings that are way off the expected values.
A: Check the software to make sure that the 'Operating pressure' is correct otherwise this will introduce a multiplying error. Also check to make sure which two calibration gases are selected. Are they the same as the actual gases you used to perform the calibration? If not you can change their values using the software. Also check to see that the pressure correction mode is set to NONE if there is NO pressure sensor attached.
- Q: The sensor does not read 20.9 - 21.0% in air (actual value is 20.95%).
A: If the room air is very humid, it will slightly affect the observed measurement or the sensor may have drifted slightly because of natural ageing. If you are using air as a calibration point then simply do a quick re-calibration in the air to compensate for this.
- Q: I messed up the calibration procedure and the analyser is not working properly.
A: Return the box to the factory defaults using the keypad or communications software, by selecting 'Default Configuration' followed by 'Write Configuration to Analyser' from the File menu. Now try re-calibrating the Rapidox.
- Q: The software will not talk to the Rapidox.
A: Make sure that you are using the correct cable, as supplied (pin 2 to pin 2 etc). A crossed RS232 cable (pin 2 to pin 3 etc.) will not work. Make sure that your COM ports are recognised by your computer. Check in your Windows device manager to see if there are any conflicts. If you have an internal modem fixed to your PC you may experience difficulties using this software. Contact Cambridge Sensotec for further advice.

Cambridge Sensotec Rapidox 1100 Oxygen Analyser Instruction Manual

Q: I selected 'Write to the Analyser' and now the Rapidox is way off calibration.

A: Only select 'Write to the Analyser' once all the values are correctly entered in the boxes on the right. The best procedure is to 'Read Analyser Configuration' and then press 'Copy' so the values in the boxes are the same as those stored in the Rapidox memory. You can then edit these values and then select 'Write to the Analyser' when finished.

Q: How do I get back to the factory calibration for my instrument.

A: Select 'Load Configuration File' from the File menu and look for the rxc file on your CD. Select this file and then select 'Write to the Analyser'. This will load the factory calibration back into the Rapidox. Alternatively you can load a standard default configuration any time using the 'Load Default' option on the File menu. This configuration will not be perfect for your analyser but will be good enough to get you started again.

11. Warranty

The Rapidox analyser has been carefully tested and inspected before shipment and is guaranteed to be free from defective materials and workmanship for a period of twelve months from date of purchase. The sensor head is replaceable and has a life expectancy in excess of 35,000 hours. However, if the analysis gas contains corrosive gases or large quantities of particulates, sensor life may be shortened. In the case of the latter, it is normally possible to insert a filter prior to the sensor head to remove the particulate material.

11.1 Conditions of Warranty:

- 1) This warranty is in addition to and does not affect any statutory rights of consumer purchasers. This warranty is valid worldwide on a back to base basis.
- 2) This warranty covers breakdowns due to design or manufacturing faults; it does not apply to damage, however caused, wear and tear, neglect, unauthorised adjustment or repair, or any items of limited natural life.
- 3) In the event of failure, please take the following action:
 - a] Refer to the “Troubleshooting” section of your instruction manual to identify and possibly correct the problem.
 - b] If the fault cannot be resolved, please contact the Cambridge Sensotec service and repair centre at the address given on the cover of the manual.
- 4) The warranty period applicable shall be 12 months from the date of purchase.

Rapidox CERTIFICATE of CALIBRATION

Date:

Rapidox Serial number:

Calibration Constant A

Calibration Constant B

Calibration Gas 1

Calibration Gas 2

Configuration Filename

Calibrated by:

Signed:

Cambridge Sensotec Rapidox 1100 Oxygen Analyser Instruction Manual